



Liebert® APM2 Lithium Battery Module

Installer/User Guide

The information contained in this document is subject to change without notice and may not be suitable for all applications. While every precaution has been taken to ensure the accuracy and completeness of this document, Vertiv assumes no responsibility and disclaims all liability for damages result from use of this information or for any errors or omissions.

Refer to local regulations and building codes relating to the application, installation, and operation of this product. The consulting engineer, installer, and/or end user is responsible for compliance with all applicable laws and regulations relation to the application, installation, and operation of this product.

The products covered by this instruction manual are manufactured and/or sold by Vertiv. This document is the property of Vertiv and contains confidential and proprietary information owned by Vertiv. Any copying, use, or disclosure of it without the written permission of Vertiv is strictly prohibited.

Names of companies and products are trademarks or registered trademarks of the respective companies. Any questions regarding usage of trademark names should be directed to the original manufacturer.

Technical Support Site

If you encounter any installation or operational issues with your product, check the pertinent section of this manual to see if the issue can be resolved by following outlined procedures.

Visit <https://www.vertiv.com/en-us/support/> for additional assistance.

TABLE OF CONTENTS

1 Important Safety Instructions	1
1.1 Personnel Safety	1
1.2 Product Safety	1
1.3 Disclaimer	1
1.4 Safety Precaution	1
2 Overview	5
2.1 Product Features	5
2.1.1 Intelligent pairing with UPS products	5
2.1.2 Perfect battery protection	5
2.1.3 Easy installation and maintenance	5
2.1.4 Ultra-high energy density	5
2.2 Product Applications	5
2.2.1 Compatible models	5
2.2.2 System structure	6
2.3 Module Appearance	6
2.4 Working Principle	8
2.4.1 Modular design	8
2.4.2 Module status	9
2.5 Introduction of Liebert® APM2 Lithium Battery Module	9
2.5.1 Battery module	9
2.5.2 Electrical control components	10
3 Installation Instructions	11
3.1 Prerequisites	11
3.2 Preparation for Installation	11
3.2.1 Tools	11
3.2.2 Confirmation of UPS installation environment	12
3.3 Handling and Unpacking	13
3.3.1 Carrying lithium battery modules	13
3.3.2 Unpacking	14
3.3.3 Re-check before installation	14
3.4 Lithium Battery Module Installation	15
3.5 Lithium Battery Module Paramset Set Up	16
4 Startup, Operation, and Commissioning	19
4.1 Notes	19
4.2 Powering On and Off	19
4.2.1 Power-on	19
4.2.2 Power-off	20

- 4.2.3 Emergency power-off 20
- 4.3 UPS Power-On Test 20
- 4.4 Commissioning Record List 21
- 5 Operation Control Display Panel 23**
- 5.1 Overview 23
- 5.2 LED Display 30
- 5.3 Operation of Touchscreen 31
 - 5.3.1 Access level login 31
 - 5.3.2 Touchscreens 32
- 5.4 Alarm List 33
- 6 Product Specification 35**
- 6.1 Applicable Standards 35
- 6.2 Environmental Characteristics 35
- 6.3 Mechanical Characteristics 36
- 6.4 Electrical Characteristics 36
- 7 Maintenance and Service 37**
- 7.1 Maintenance Precautions 37
- 7.2 Preventive Maintenance 37
- 7.3 Module Replacement 37
- 7.4 Routine Maintenance 38
 - 7.4.1 General 38
 - 7.4.2 Diagnosis of common problems 39
 - 7.4.3 Emergency management 39
- 7.5 Maintenance Record of Lithium Battery Module 39
- 8 Packaging, Transportation, Storage 41**
- 8.1 Package 41
- 8.2 Transport 41
- 8.3 Storage 41
- Appendices 43**
- Appendix A: Technical Support and Contacts 43
- Appendix B: Battery Backup Timetable 44
- Appendix C: Hazardous Substances and Content 46

1 Important Safety Instructions

1.1 Personnel Safety

A Vertiv authorized engineer must install and commission the UPS. Failure to do so can cause product malfunction or personal safety risk.

Read the UPS manual and safety precaution carefully, failure to do so can cause product malfunction or personal safety risk.

NOTE: The Vertiv™ Liebert® APM2 UPS is not manufactured to support the life support equipment.

Never dispose of the internal or external battery of this product in a fire, as it may explode can cause risk of personal safety.

1.2 Product Safety

- If this product will be stored or remain de-energized for a long period, it must be placed in a dry and clean environment within specified temperature range.
- This product should be used in an appropriate operating environment. For details, refer to the section on the environmental requirement in this manual.
- This product is designed for application in the following conditions:
 - Where the temperature and relative humidity are outside the specifications.
 - Is not subjected to vibrations or shocks.
 - Where conductive dusts, corrosive gases, salts, or flammable gases are not present.
 - Away from heat sources or strong electromagnetic interferences.

1.3 Disclaimer

Vertiv disclaims all responsibility and/or liability for any defects or malfunction caused by the following actions:

- Any use or operation outside of the [Product Specification](#) on page 35, including application ranges or operating environments.
- Any unauthorized product operations, modifications, or improper installation.
- Any forceful measures used when operating the product.
- Any other product related actions not in compliance with the instructions in this document.

If you need product assistance or have additional product questions, contact your Vertiv Technical Support representative.

1.4 Safety Precaution

Always pay attention to the following safety symbols.



WARNING! Used to alert the user to the risk of death or severe injury should the unit be used improperly.



CAUTION: Used to alert the user to the risk of injury or equipment damage should the unit be used improperly.

IMPORTANT! Used to advise the user to carefully read and observe this unit though it may not cause damage. This manual contains the installation and use of the Vertiv™ Liebert® APM2 lithium battery module. Vertiv recommends to read this manual carefully before system installation and operation.

Liebert® APM2 lithium battery modules must be commissioned and maintained by Vertiv engineer or its agent. Failure to do so may cause risk of personal safety and lead to equipment failure, and the resulting damage to the equipment is not covered by the warranty.

Applicable standards

- This equipment complies with CE 2014/35/EU (Low Voltage Safety), 2014/30/EU (EMC) and 2011/65/EU (RoHS), as well as the following product standards:
 - *IEC62040-1 General Safety Requirements for Use of Operating Areas
 - *IEC62040-2 EMC, Class C2
- The equipment must be installed in accordance with the above requirements and using the accessories specified by the manufacturer.

Battery safety instructions

- When installing and applying Liebert® APM2 lithium battery module products, refer to the user manual before use.
- Check the orientation of the positive and negative terminals before installation and removal.
- Terminals or wires to the lithium battery module, use insulated tools, and pay attention to insulation protection against short circuits.
- When not in use for a long period of time, the battery should be stored in a cool and dry place ($\leq 35^{\circ}\text{C}$, 30% or more SOC, and charge/discharge the whole machine every three months).
- Do not place the battery in direct sunlight or near a heat source.
- Do not wear metal jewelry (such as rings, watches, ornaments, and so on) when touching the lithium battery module.
- Do not place the battery outside the operating temperature range specified in this manual.

Equipment maintenance

- All internal maintenance and servicing of the equipment requires the use of tools and should be carried out by trained personnel. Devices behind protective covers that require the use of tools to open are not user serviceable.
- The Liebert® APM2 lithium battery module fully meets the safety requirements for equipment in the area of use and operation. The Liebert® APM2 lithium battery module carries hazardous voltages internally, but is not accessible to non-maintenance personnel. There is no hazard in operating the equipment in compliance with general specifications and following the steps recommended in this manual.



WARNING! Power cables must be routed in a metal raceway or metal floor trough to prevent cable damage and reduce electromagnetic radiation.



WARNING! Prohibit wiring inside the Vertiv™ Liebert® APM2 lithium battery module cabinet that is not related to this equipment.

Prohibitions

- Do not exceed the maximum allowable charge/discharge ratio.
- Do not disassemble or modify the lithium module.
- Do not throw or hit the lithium module.
- Do not pierce the lithium module with sharp objects (such as nails, knives, pens, drills, and so on).
- Do not mix with other models of lithium modules.
- Do not squeeze the lithium module during use.
- Do not leave the battery in a place where the temperature is higher than 60°C.
- Do not place the battery in a microwave oven or a high pressure container.
- Do not connect the positive and negative terminals with conductive materials (such as metal, wires, and so on).
- It is not permitted to wet or immerse the battery in water or seawater.
- Do not use the batteries in ways other than in the manufacturer's user manual.
- The use of products with poor insulation protection of the lithium module case is prohibited.

Battery voltage exceeds 200 VDC

- All physical care and maintenance of batteries requires the use of tools or keys and should be carried out by trained personnel.
- When the batteries are connected, the voltage at the battery terminals will exceed 200 VDC, making personal contact fatal.
- The manufacturer has provided precautions to be observed when using or in the vicinity of lithium modules, which should be observed at all times. Particular attention should be paid to the recommendations concerning local environmental conditions and the provision of protective clothing, first aid equipment and fire fighting equipment.

IMPORTANT! The communication board is sensitive to electrostatic discharge, implement ESD prevention measures when managing any communication board.

Preventing battery short circuit hazards

- A short circuit of the battery will cause an instantaneous high current, which will release a large amount of energy and may cause fire and other accidents, jeopardizing the safety of persons and property.
- It is prohibited to work with electricity, during installation, maintenance, and other operations, the battery circuit needs to be disconnected from the front panel air switch to keep the system disconnected.
- The use of insulated tools is required during installation and maintenance, goggles and rubber gloves should be worn before installation, maintenance and other operations.

- When installing and connecting copper rows or cables between lithium modules, you need to be accompanied by safety personnel.
- When installing and connecting the lithium module, it is necessary to lock the bolts according to the torque required by the manual.
- Battery products are not permitted to be near sources of ignition or water, not even a small sporadic fire or water droplets.
- Vertiv™ Liebert® APM2 lithium battery modules and their battery modules are not waterproof or dustproof.

IMPORTANT! Dispose the batteries in accordance with local laws and regulations.

NOTICE

The lithium battery deployment room needs to be equipped with fire protection facilities. Heptafluoropropane, perfluorohexanone, dry powder extinguishing, and firefighting sand are recommended.

This manual covers following module:

Table 1.1 Module

Product	Model Number
Liebert® APM2 Lithium battery module	APM 0120kBLI01
NOTE: Rated voltage of single module: 237.6 V, capacity 14 Ah. NOTE: Battery cluster rated voltage: 475.2 V, capacity 14 Ah.	

2 Overview

This chapter describes the features, product introduction, system design, and key component functions of the Vertiv™ Liebert® APM2 lithium battery module.

2.1 Product Features

Liebert® APM2 lithium battery module is a ternary lithium battery product, which is used with the APM2 120k UPS to provide backup energy storage. The Liebert® APM2 lithium battery module, supports multiple battery clusters to meet the requirements of different capacity UPS configuration. The product has the following features:

2.1.1 Intelligent pairing with UPS products

Liebert® APM2 lithium battery module communicates with UPS through CAN communication, ensures the real time exchange of operating data, and intelligent protection and monitoring, program upgrade feature is available with UPS HMI over RS-485 communication mode.

2.1.2 Perfect battery protection

The battery management system (BMS) of the Liebert® APM2 lithium battery module has a perfect battery protection function to ensure the automatic and safe operation of the system. The system works independently when UPS communication is abnormal and protects battery cluster systems. Provide managed, predictable, and uninterrupted power supply to critical equipment.

2.1.3 Easy installation and maintenance

The Liebert® APM2 lithium battery module has a redundant design that supports quick online maintenance, and the module can be replaced in less than 3 minutes.

2.1.4 Ultra-high energy density

The system adopts ternary lithium battery, which has high energy storage density, small height, and volume and long service life.

2.2 Product Applications

2.2.1 Compatible models

Table 2.1 Compatible Model

Product Name	Product External Model	Remark
APM2.0 120 kVA UPS Frame1 400 V	APM 0120kMH16FY02S00	CE

2.2.2 System structure

Figure 2.1 Vertiv™ Liebert® APM2 Lithium Battery Module Structure

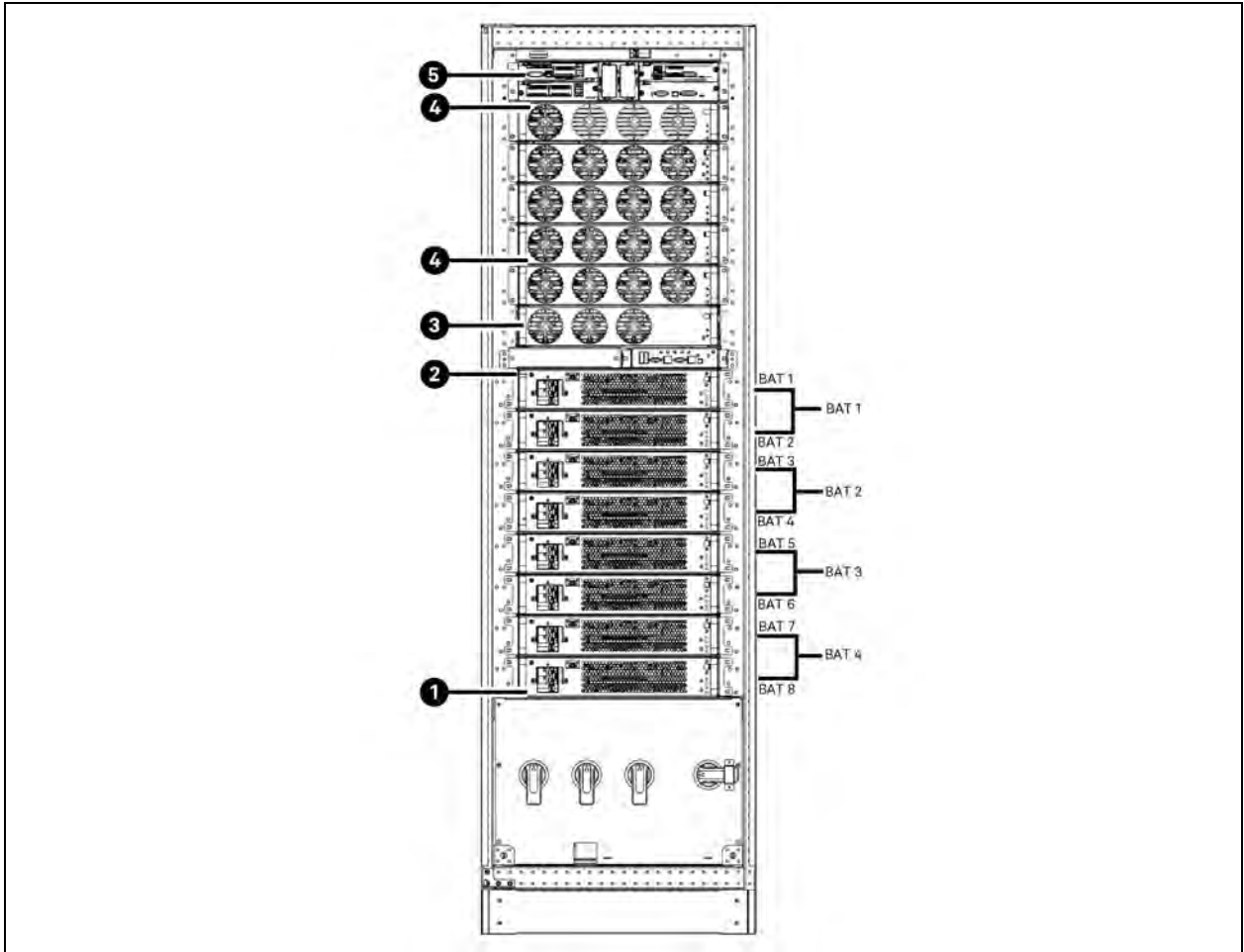

Item	Description
1	Battery
2	Battery module
3	Bypass module
4	Power module
5	Controller

2.3 Module Appearance

This chapter describes the structure of the Liebert® APM2 lithium battery module and its components.

Figure 2.2 Vertiv™ Liebert® APM2 Lithium Battery Modules

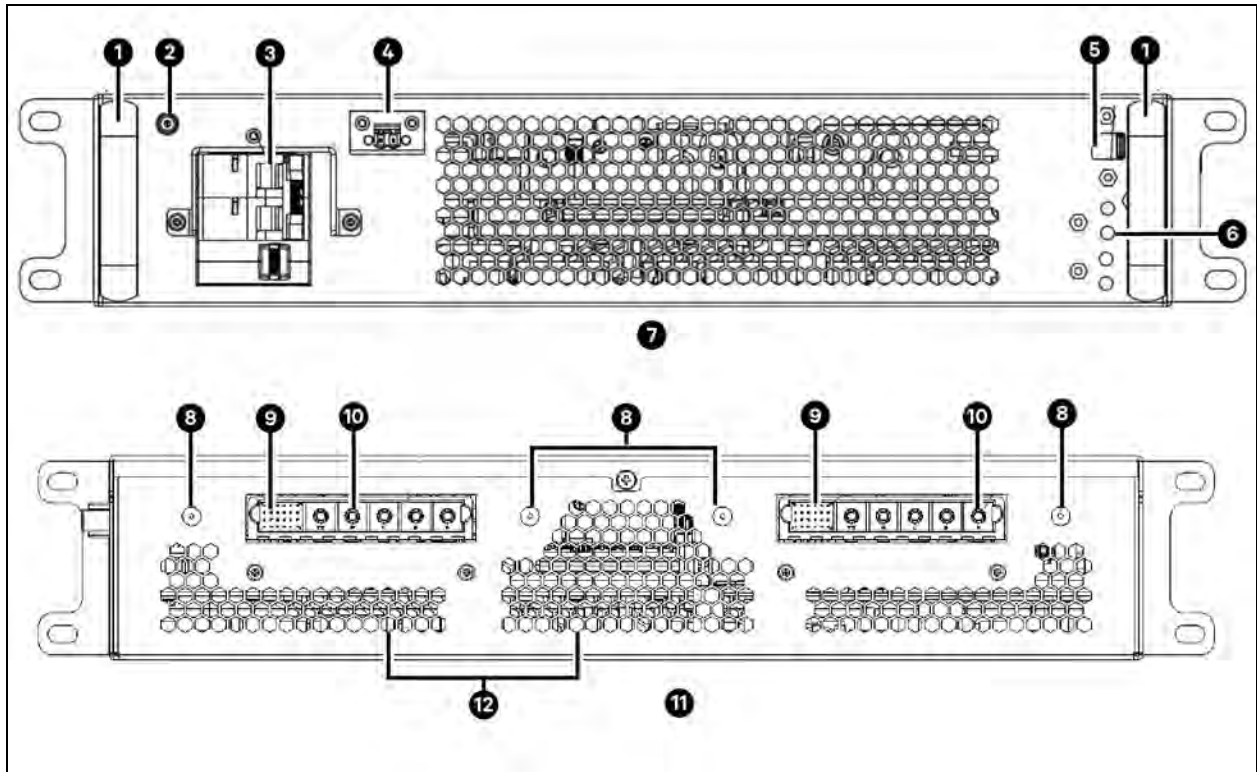

Item	Description	Item	Description
1	Handle	7	Front Panel of Liebert® APM2 lithium battery module
2	12 V external input interface	8	Retaining pin
3	MCB low voltage control switch	9	Communication cable wiring ports
4	RS-485 communication interface	10	Power cable wiring port
5	Lock switch	11	Rear Panel of Liebert® APM2 lithium battery module
6	Status indicator	12	Heat sink

Figure 2.3 Lock Switch

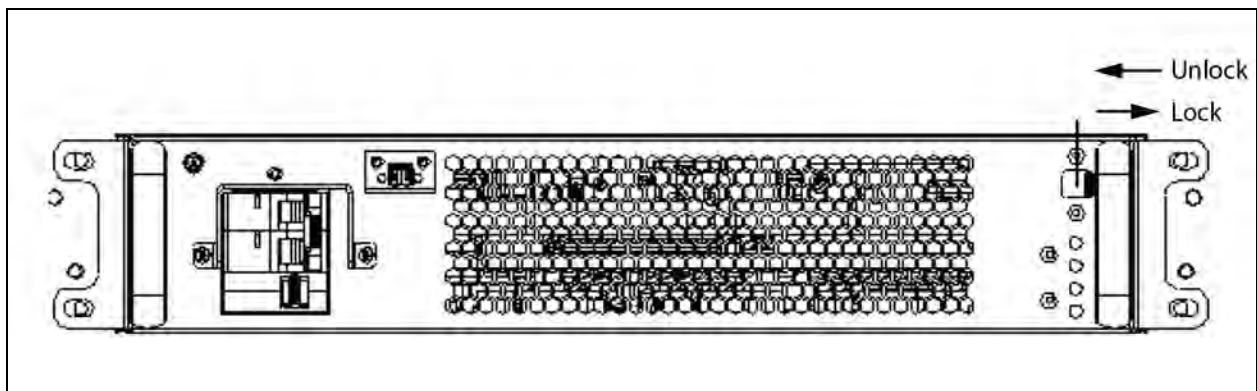

2.4 Working Principle

The Vertiv™ Liebert® APM2 lithium battery modules, along with UPS equipment, provide uninterruptible power supplies for communications, and data processing equipment, as a backup energy storage system for critical equipment.

2.4.1 Modular design

The electrical principle of Liebert® APM2 lithium battery module system is configured with two levels of BMS protection, which are BMS and control module. The Liebert® APM2 lithium battery module is internally designed with two protections, which are DC contactors and fuses, and the electrical schematic diagram of the Liebert® APM2 lithium battery module is shown in Figure 2.4 below.

Figure 2.4 Liebert® APM2 Lithium Battery Module System Schematic Diagram

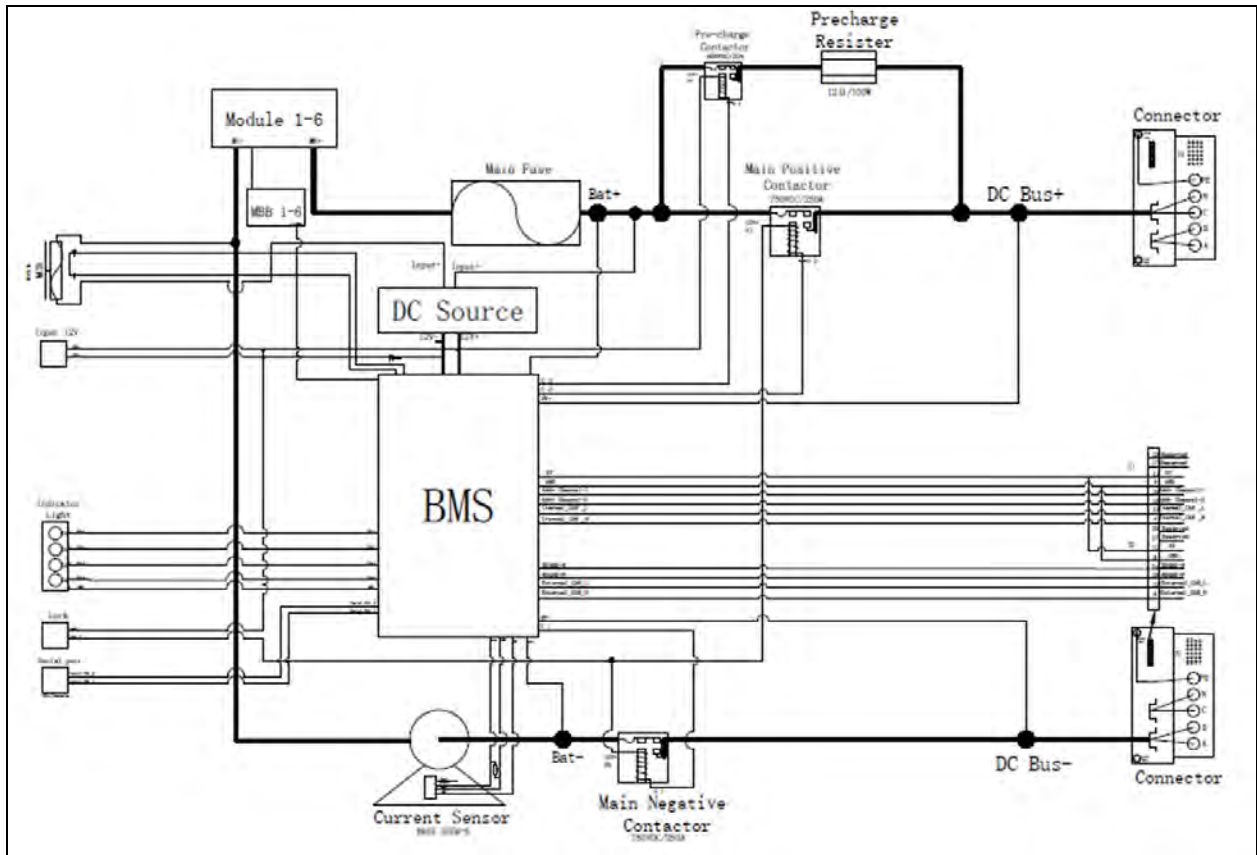

Item	Description	Item	Description		
1	Module 1-6	Battery module	9	Serial port	RS-485 serial port
2	MCB	Miniature circuit breaker	10	Main fuse	Main fuse
3	Input 12 V	External 12 V input	11	DC source	DC auxiliary power supply
4	Indicator light	Light panel	12	BMS	Battery management system control board
5	Contactor	High and low voltage connectors	13	Negative contactor	Main negative contactor

Item	Description		Item	Description	
6	Current sensor	Hall DC sensors	14	Positive contactor	Main positive contactor
7	Pre-charge contactor	Pre-charge contactor	15	MBB 1-6	Module acquisition equalization board
8	Pre-charge resistor	Pre-charge resistance			

2.4.2 Module status

Resting state

The Vertiv™ Liebert® APM2 lithium battery module system is in a non-charging and non-discharging state, the BMS is active and the main circuit is ON.

Charging state

When the Liebert® APM2 lithium battery module is in the charging state, the UPS is allowed to charge the battery cluster. The charging current is sent by the lithium battery module, and the UPS controls the charger to output the current. When the battery cluster cell voltage reaches 4.18 V or the total battery voltage reaches 550 V, the charging stops, and the system still has the capability of zero delay discharge.

Discharging state

The Liebert® APM2 lithium battery module discharges to the UPS. The discharge stops when the UPS system's end-of-discharge (EOD) condition is triggered due to either low battery voltage or high battery temperature.

Dormant state

When the battery power is extremely low, the battery enters a dormant state, and the system automatically shuts down the main circuit and the BMS power supply circuit to avoid further depletion of battery power.

Fault state

If the Liebert® APM2 lithium battery module displays a fault message that cannot be eliminated automatically, contact your local Vertiv customer service center for additional technical support.

2.5 Introduction of Liebert® APM2 Lithium Battery Module

This chapter provides an introductory description of the key components of the Liebert® APM2 lithium battery module.

2.5.1 Battery module

The Liebert® APM2 lithium battery module consists of six ternary lithium battery modules with a rated voltage of 39.6 V (3.6 V/CELL) in series, each module contains eleven battery cells, and each battery cell is formed by five ternary lithium cells in parallel.

Figure 2.5 Structure Diagram of Vertiv™ Liebert® APM2 Lithium Battery Module

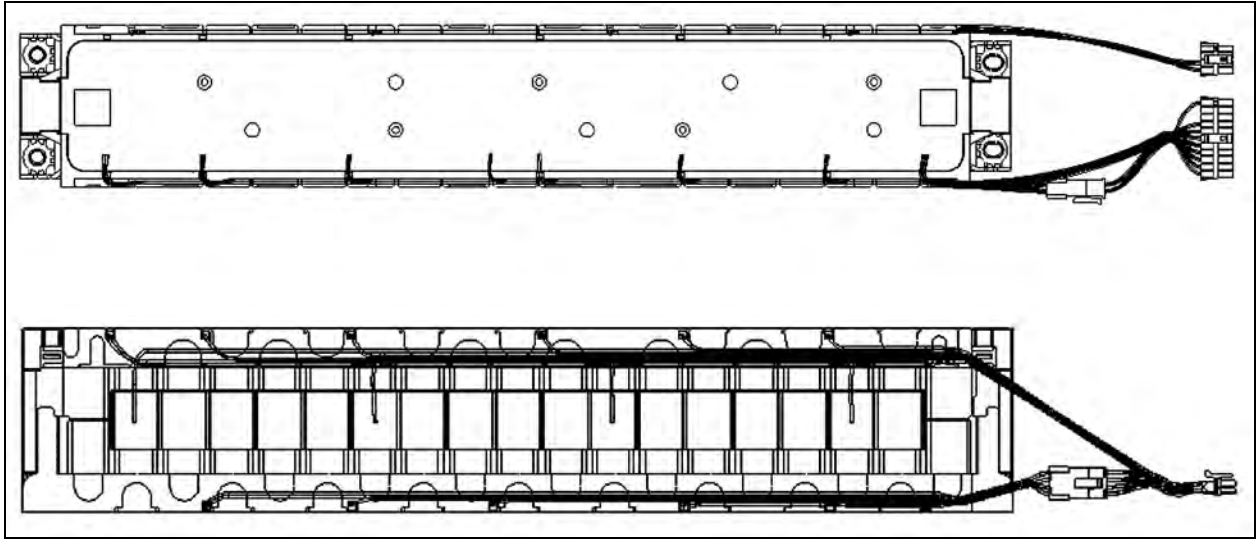

2.5.2 Electrical control components

The key components of the electrical control of the Liebert® APM2 lithium battery module are specified as below:

- **MCB:** It is the MCB of the low voltage battery power supply system with the breaking capacity of 6 A, 440 VDC. It is used as the switch to supply power to the low voltage system of the lithium battery module. When the battery needs to be powered on after being placed into the cabinet, close the MCB first to keep the low voltage system powered on.
- **Main contactor:** For lithium module ON and OFF active control.
- **Fuse:** Passive protection device, the fuse supports the lithium battery module when the external short circuit occurs fast fuse, to protect the main circuit battery or device, to prevent dangerous events.
- **Lock switch:** Used for lithium battery module into the cabinet detection, control of the main circuit contactor unilateral control and system contactor disconnection and lithium module cold start applications.

3 Installation Instructions

This chapter briefly describes the mechanical installation of the Vertiv™ Liebert® APM2 lithium battery module, including precautions, initial inspection, environmental requirements, and mechanical installation.

3.1 Prerequisites

The Liebert® APM2 lithium battery module must work with the Vertiv™ Liebert® APM2 120 kVA UPS. The UPS must meet the operating environment requirements of the lithium battery module. Because each site has its particularity, this section provides installation personnel with general installation procedures and methods, which are handled according to the specific site conditions.

IMPORTANT! Do not unpack until a Vertiv authorized service engineer arrives.

IMPORTANT! Installation of the module should be carried out by a service engineer according to the instructions in this section.



WARNING! Risk of high battery voltage. Can cause personal injury or death. When the battery is connected, the voltage at the battery terminals may exceed the 400 VDC hazardous voltage.

- Wear eye protection to avoid accidental arc damage to the eyes.
- Remove rings, watches, and all other metal wearables.
- Use tools with insulated handles and wear rubber gloves.
- If the battery electrolyte leaks or the battery is damaged, this battery module must be replaced and scrapped according to local regulations.
- If skin contact with the electrolyte occurs, rinse immediately with water.
- Module short-circuiting and battery collision are strictly prohibited.
- Modules are strictly prohibited to be close to high temperature heat sources, and are strictly prohibited to be close to water sources.
- If the lithium module has been stored for more than three months, it needs to be re-tested by a professional engineer before it can be put into use.

















3.2 Preparation for Installation

3.2.1 Tools

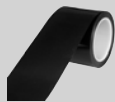

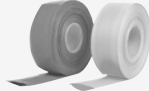
WARNING! Risk of electric shock and hazardous voltage. Can cause personal injury or death. The Installation tools under live operation must be insulated. The tools listed in Table 3.1 on the next page are for reference only. For onsite installation and connection, use the actual required tools.

Table 3.1 Tools

Name	Drawing	Name	Drawing
Electric hand drill		Adjustable wrench	
Slotted screwdriver		Cross head screwdriver	
Stepladder		Forklift	
Drill		Wire cutting plier	
Claw hammer		Diagonal cutting plier	
Insulating shoes		Antistatic gloves	
Electrician knife		Cable tie	
Insulating tape		Insulating gloves	
Crimping plier		Heat shrinkable tube	
Insulated torque wrench		Torque screwdriver	
Multimeter		Clip-on ammeter	

3.2.2 Confirmation of UPS installation environment

Before installing the Vertiv™ Liebert® APM2 lithium battery module, make sure that the supporting UPS is in place and that the operating environment meets the following conditions:

1. It should be installed in a cool, dry, clean and well-ventilated indoor environment with constant temperature and humidity. It should be installed on concrete or other non-flammable and flat mounting surface. Environmental dust cannot contain conductive dust (such as metal powder, sulfide, sulfur dioxide, graphite, carbon fiber, conductive fiber, and so on), acid fog or other conductive media (strong ionizing substances). The specific environmental indicators must meet the requirements of relevant national standards and specifications and within the range of indicators specified in this manual. Refer **Table 6.2** on page 35.
2. Keep a distance of at least 500 mm between the back of the UPS and the wall. This prevents the ventilation and heat dissipation of the UPS and increases the internal temperature of the cabinet. If necessary, install an indoor exhaust fan to prevent the room temperature from increasing excessively. Keep the UPS cabinet away from the heat source and air conditioner outlet.
3. In a dusty environment, install an air filter on the vent of the equipment room. At the same time, replace the air filter or clean the dust on the air filter to avoid affecting the heat dissipation efficiency of the UPS.
4. If there is no need to install the lithium battery module immediately, it must be stored in a dry, cool and well-ventilated place using the original packaging from Vertiv, with the optimal storage temperature being 20°C to 25°C.

NOTE: The indoor environment where the Vertiv™ Liebert® APM2 lithium battery module is installed must be equipped with constant temperature and humidity precision air conditioners.

NOTE: The ambient temperature of the lithium battery module should be kept constant. Ambient temperature is the main factor affecting battery capacity and life. The optimum operating temperature of a battery ranges from 15°C to 30°C. Operating at a temperature higher than this threshold shortens the battery life. Operating at a temperature lower than this threshold shortens the battery backup time.



WARNING! During battery storage, periodically charge the battery according to the battery manufacturer instructions. In the charging process, temporarily connect the UPS to the mains and activate the battery by recharging the battery.

3.3 Handling and Unpacking

3.3.1 Carrying lithium battery modules

IMPORTANT! Lithium battery modules must be handled by trained professionals.

IMPORTANT! The lithium battery module must be handled with care to avoid collision and falling.

IMPORTANT! Lifting equipment used for handling lithium batteries must have sufficient lifting capacity.

The lithium battery module is packed in a wooden case. Use an electric forklift or a manual forklift to move the lithium battery module. Ensure that the center of gravity of the lithium battery module is in the center of the fork of the moving device.

When moving the forklift, ensure that the end of the forklift exceeds the module packing tray to avoid damage to the lithium battery module package due to force.

It is recommended not to move more than four layers at the same time. Do not lift the lithium battery module too high when using an electric forklift.

NOTE: Lithium modules are packaged independently during transportation, and must be kept upright and upward during transportation and handling, and must not be tipped over for transportation or handling.

3.3.2 Unpacking

NOTE: Before removing the packaging, visually inspect the packaging for damage. If there is any abnormality, contact the local customer service center of Vertiv immediately for assistance.

Unpack the battery under the guidance of a Vertiv authorized service engineer as follows:

1. Use an electric forklift to carry the lithium battery module boxes to the installed UPS rack.
2. Cut off the packing tape. Cut off the packing tape with pliers, remove the plastic film, open all the locks on the battery box, and remove the wooden upper cover. Remove the upper fastening foam, disassemble the plastic bag wrapping the lithium module, and take out the lithium battery module, as shown in **Figure 3.1** below.

Figure 3.1 Removing Packing Strips and Wooden Top Cover Plates

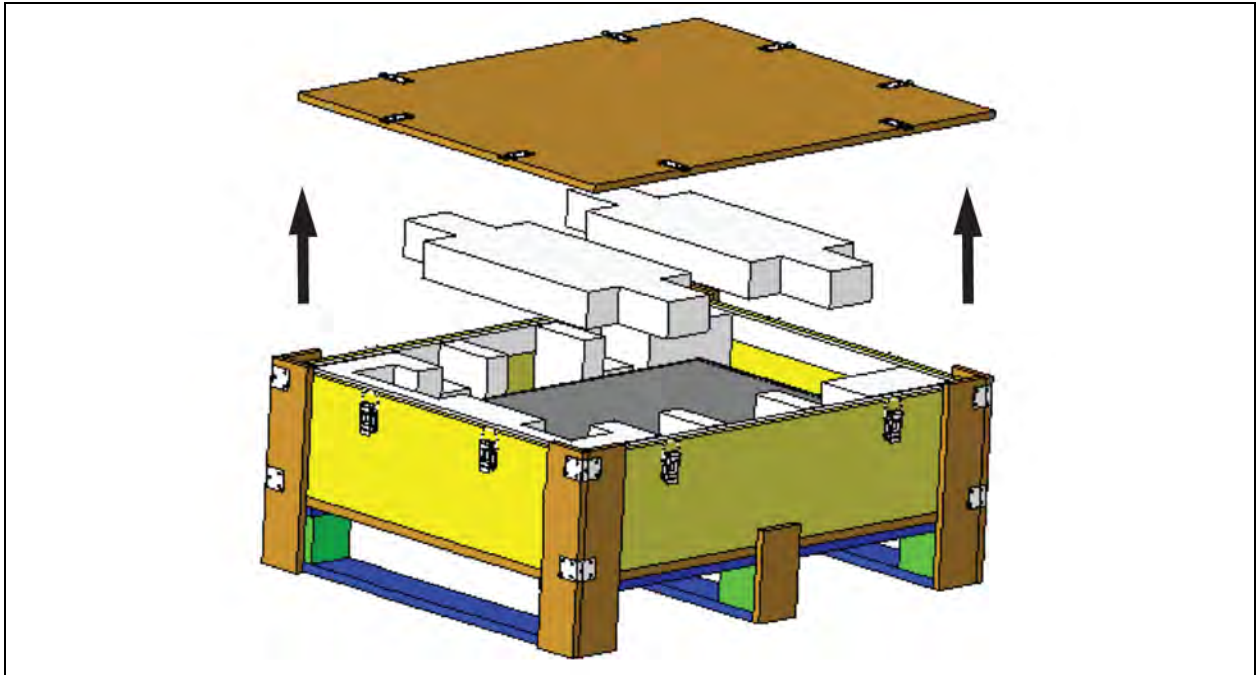

3. Unwrap the adhesive bag wrapping the lithium battery module and remove the lithium battery module.

NOTE: The weight of lithium module is more than 35 kg, when you take out the module from the packing box, you must use lifting tools or more than two people to carry it, and avoid collision and fall during the carrying process.

NOTE: Before removing the lithium module, make sure the air switch is in the OFF position and the lock switch is turned to unlock.

4. Place the lithium battery module onto the auxiliary lifting device. If no similar device is available, it is recommended that this step be performed when the module needs to be mounted to the rack.

3.3.3 Re-check before installation

Before installing the lithium battery module, the following checks should first be performed:

1. Ensure again that the environment of the machine room meets the environmental requirements specified in the [Product Specification](#) on page 35, in particular the ambient temperature, ventilation conditions and dust conditions.

2. Confirm that the supporting UPS rack is installed correctly, and that the system is not energized.
3. Check the product label to confirm the correctness of the equipment. The device name plate is affixed to the case cover of the lithium battery module, indicating the battery model, voltage, capacity, and other parameters. If the device model does not match, contact the Vertiv customer service center in time.

3.4 Lithium Battery Module Installation

Vertiv™ Liebert® APM2 lithium battery modules are all packaged in a single, independent package, and the lithium battery modules all need to be installed onsite.

1. Remove the dummy panel on the cabinet that corresponds to the location of the lithium battery module.
2. Remove the lithium battery module from the box or operate the auxiliary lifting platform to align the mounting position.
3. Working from the bottom to the top, insert the lithium battery module into the UPS cabinet and lock the module in place using the screws included in the accessories once the module is in place.

NOTE: When installing the lithium battery module, pay attention to the snap in the middle of the body and do not use excessive force to avoid damaging the rear of the module and the connector on the cabinet.

NOTE: When installing the upper lithium battery module, it is recommended to use a lifting tool.

NOTE: Dummy panels are retained in locations where lithium battery modules are not installed when the lithium battery modules are not fully loaded.

NOTE: Once the module is installed, do not close the air switch and toggle the lock switch until power ON is confirmed.

4. After the lithium battery module is inserted into the rack, the power output and communication of the lithium battery module are connected to the rack without additional cables.
5. When removing the installed module, ensure that the circuit breaker is OFF, and the lock switch is in the unlocking position then take out the screws and pull out the module slowly through the module handle. If half of the module has been taken out is displayed, half of the module has been taken out. In this case, two people need to work together to lift the module out. Do not operate the module by one person to avoid falling after the module is pulled out.

3.5 Lithium Battery Module Paramset Set Up

Open your laptop's Paramset software and left click on the red box labeled Battery Parameter.

Figure 3.2 Paramset Software

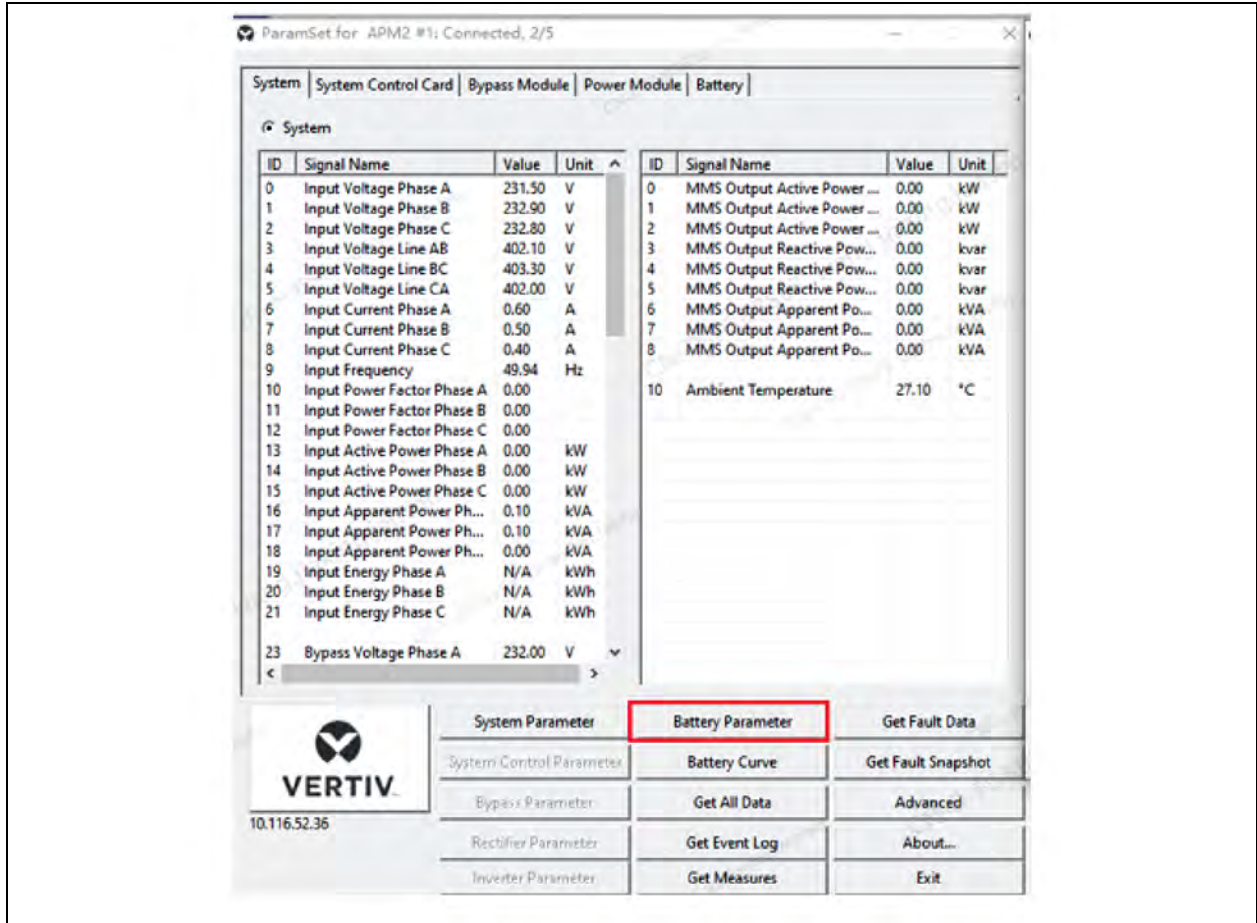

Set battery parameters:

Set the battery material type as 7, battery cabinet type as 3, the number of built-in battery modules for 8, the number of external battery cabinets for 0, the number of batteries in each group for 132, the battery capacity of 14, the battery charging current limiting current for 1.1, the battery single float voltage of 4.180, the battery single average charging voltage of 4.180.

Figure 3.3 Configuration of Battery Parameters_1

Parameter Name	Value	Memo
Battery Chemistry Type	7	1-8(1)
Battery Cabinet Type	3	Setting range is as below
Internal Battery Module Count	8	1-16(8)
External Battery Cabinet Count	0	Setting range is as below
External Battery Cabinet1 String/Module Count	N/A	1-32(16)
External Battery Cabinet2 String/Module Count	N/A	1-32(16)
External Battery Cabinet3 String/Module Count	N/A	1-32(16)
External Battery Cabinet4 String/Module Count	N/A	1-32(16)
External Battery Cabinet5 String/Module Count	N/A	1-32(16)
External Battery Cabinet6 String/Module Count	N/A	1-32(16)
External Battery Cabinet7 String/Module Count	N/A	1-32(16)
External Battery Cabinet8 String/Module Count	N/A	1-32(16)
Battery Cell Count Per String	132	Setting range is as below
Battery Cell Nominal Ah/W	14	Setting range is as below
Battery Life	10	Setting range is as below
Battery Charge Current Limit	1.100	Setting range is as below
Battery Float Charge Voltage	4.180	Setting range is as below
Battery Equalize Charge Voltage	4.180	Setting range is as below
Auto Equalize Charge	2	1: Enable 2: Disable(default)
Current Threshold of Float Charge to Auto Equalize Charge	0.050	0.001-0.07(0.05)*C
Current Threshold of Auto Equalize Charge to Float Charge	0.020	0.001-0.025(0.02)*C
Auto Equalize Charge Protection Time Limit	8	8-100(8)hr

1: Low Rate Lead Acid Battery 2: High Rate Lead Acid Battery
 4: Ni-Cd Battery
 5: LMO Battery
 6: LFP/LFMP Battery
 7: NMC/NCA Battery
 8: LTO Battery

Buttons: Save To File, Load From File, Renew All Parameters, OK

Set the battery system communication protocol to 7, charger overvoltage fault detection point is 4.350, charging cutoff protection point is 4.270, minimum battery EOD voltage is 2.90, maximum battery EOD voltage is 2.90.

Figure 3.4 Configuration of Battery Parameters_2

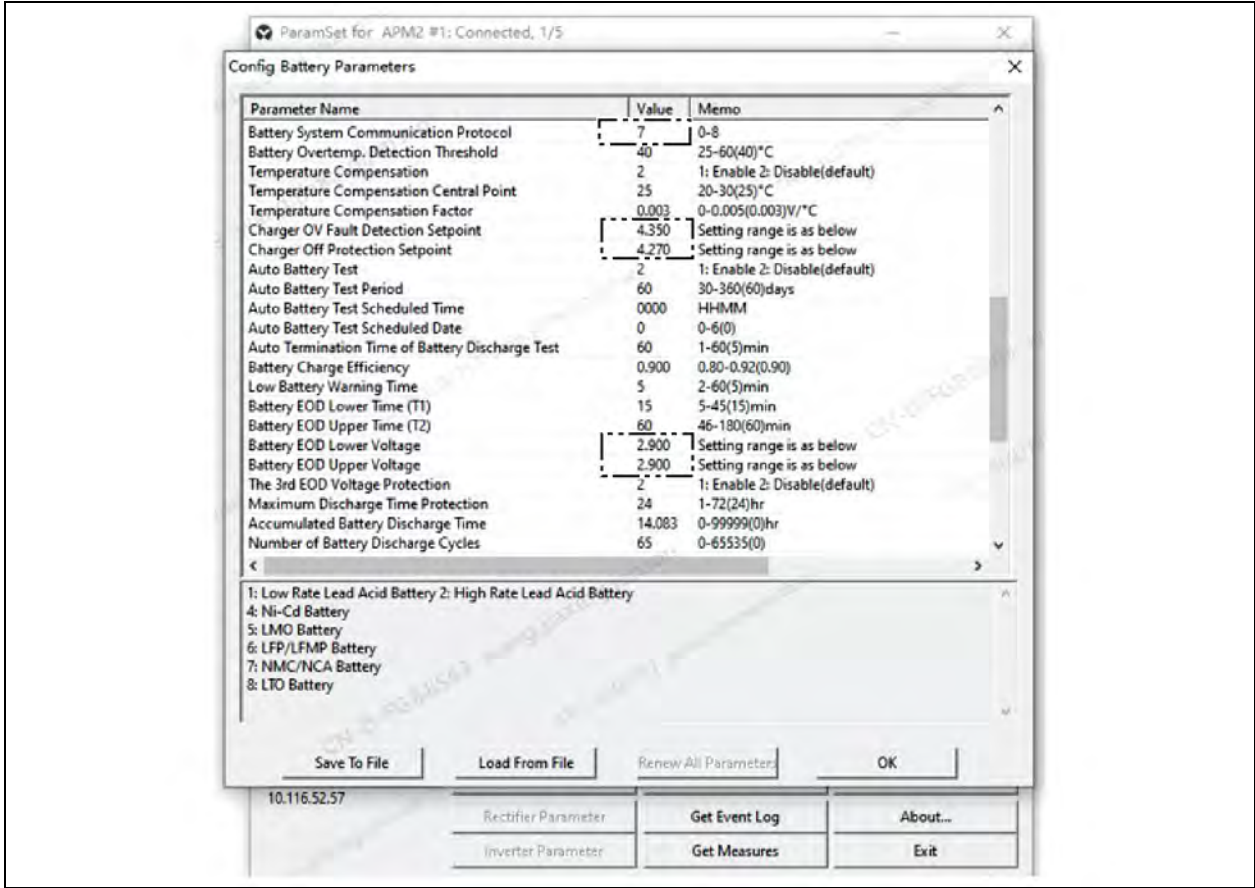

Other parameters are unchanged by default, save the parameters to a file after the setup is finished.

4 Startup, Operation, and Commissioning

This chapter describes the process and operation of powering ON and OFF the Vertiv™ Liebert® APM2 lithium battery module.

4.1 Notes

NOTE: Operate the UPS only after it is commissioned and started by the Vertiv authorized engineer.

NOTE: Wear proper personal protective equipment (PPE) when powering on a lithium battery module for the first time.

IMPORTANT! Before installing the lithium battery module into the cabinet, ensure that the lithium battery module cannot be mixed with other types of battery modules such as lead-acid modules.



WARNING! Hazardous mains and/or battery voltage:

Do not open and the components behind the UPS inner door. Only qualified maintenance personnel are allowed to open the inner door of the UPS, with maintenance tools.

At any time, the DC input and output terminals of the Liebert® APM2 lithium battery module can have dangerous voltages.

- All operations and touchscreen display referred in the operating procedures are described in the user's manual of the UPS and in [Operation Control Display Panel](#) on page 23.
- During operation, the buzzer alarm may appear at any time, the sound alarm can be eliminated on the touchscreen but cannot eliminate the alarm state.
- Before carrying out commissioning of lithium module startup, the supporting UPS should be tested individually to ensure that the UPS is working properly, and the load is within the appropriate range so as not to cause battery overload protection.
- Ensure that the number of batteries is matched to the load of the matching UPS application.
- Ensure that the lithium battery module blank is disconnected, and the lock switch is in the unlocked state.

4.2 Powering On and Off

4.2.1 Power-on

This operation will electrically charge the output terminals of the lithium module, so the operator must wear the personal protection equipments before powering ON the lithium module.

IMPORTANT! Vertiv service engineer must power ON the lithium-ion module and confirm that the module is working normal before transferring to the user for operation.

1. Close the circuit breaker of the lithium battery module and turn the lock switch to the locked state.
2. After the lithium battery module is powered ON, wait about 1 minute. After the contactor inside the module is plugged in, the module is powered on.

4.2.2 Power-off



CAUTION: This operation may affect the load power supply when the UPS battery is operating in discharge mode.

1. When the lithium battery system needs to be powered OFF, it is recommended that the UPS be operated to shut down the inverter output.
2. Disconnect the circuit breaker of the lithium battery module.
3. To pull out the lithium battery module, turn the lock switch to the unlocked state, and then refer to [Lithium Battery Module Installation](#) on page 15 for operation.

4.2.3 Emergency power-off

When the lithium battery module is operating in normal state, you can turn the lock switch to the unlocked state, which will make the lithium battery module disconnect from the power supply. User can also disconnect the battery by pressing the emergency shutdown *EPO* button of the UPS. For details, refer the SL-71058 Vertiv™ Liebert® APM2 300 to 600 kVA Modular UPS User Manual and SL-71076 Vertiv™ Liebert® APM2 30 to 120 kVA Modular UPS User Manual.

The UPS EPO is used to shut down the entire system, to cut off the load power supply (including inverter and bypass output) and stop charging or discharging batteries in emergency situations (such as fire or flood). To shut down the only lithium battery module, refer [Powering On and Off](#) on the previous page for specific operations.

4.3 UPS Power-On Test



CAUTION: Do not press the battery cold start button before the battery high voltage indicator is illuminated.



CAUTION: This procedure will energize the UPS output terminals. If there is a load connected to the UPS output terminals, verify with the user that it is safe to supply power to the load. If the load is not ready to receive power, disconnect the load connection switch and place a warning label on the switch.

1. Turn on the lock switch and circuit breaker on the lithium battery module. The BMS status indicator turns ON. Wait about 1 minute for the lithium battery module to get completely powered on. In this case, user can turn on the external mains input switch of the UPS and start the UPS. User can also turn on the UPS in battery mode by cold starting the battery. (For details about UPS operations, refer the SL-71058 Vertiv™ Liebert® APM2 300 to 600 kVA Modular UPS User Manual and SL-71076 Vertiv™ Liebert® APM2 30 to 120 kVA Modular UPS User Manual.).
2. After the UPS is started, ensure that the UPS output is normal, and the output voltage and frequency meet the preset values. Close the load switch to supply power to loads. Check the battery SOC, charge and discharge current, temperature, and backup time on the UPS screen.
3. After the UPS starts, turn off the mains input switch and switch the UPS to battery mode. Battery mode When the power is ON, turn on the UPS input switch. The UPS switches from battery mode to mains power supply. At the same time, the lithium battery module switches from discharge to charge.

4.4 Commissioning Record List

The commissioning record is given in the **Table 4.1** below for user reference.

Table 4.1 Reference Commissioning Record List

Form	Test Items	Inspection Standards	Result	Test Items	Inspection Standards	Result
Battery module	Battery module indicators	Normal		Display status	Each item shows compliance with requirements.	
Control section	Display operating conditions	No scrolling, messy screen		Battery information display	Normal display	
	System parameters	Setting is correct				
	Time display	Timing is correct.		Address settings	The address is correct.	
	Contactors status	Closed and normal		Battery charge and discharge	Current discharge is negative, charge is positive, charge/discharge state is correct.	
	AC start	AC start normal		DC start	DC start normal	
	Temperature and humidity display	Data is normal and recorded		Environmental humidity	Data is normal and recorded	
Cluster voltage difference	Module 1 total voltage	Pressure difference with other modules less than 10 V.		Module 5 total voltage	Pressure difference with other modules less than 10 V.	
	Module 2 total voltage	Pressure difference with other modules less than 10 V.		Module 6 total voltage	Pressure difference with other modules less than 10 V.	
	Module 3 total voltage	Pressure difference with other modules less than 10 V.		Module 7 total voltage	Pressure difference with other modules less than 10 V.	
	Module 4 total voltage	Pressure difference with other modules less than 10 V.		Module 8 total voltage	Pressure difference with other modules less than 10 V.	
Battery parameter logging	Maximum cell voltage	Record		Maximum cell voltage	Record	
	Maximum cell temperature	Record		Maximum cell temperature	Record	

This page intentionally left blank

5 Operation Control Display Panel

5.1 Overview

Display HMI touch control panel of the Vertiv™ Liebert® APM2 lithium battery module UPS Cabinet (referred to as the touchscreen), collect information about the operating status of the Liebert® APM2 lithium battery module and displays it in the form of a graph or text. The touchscreen allows user to perform operations such as switching on/off/fault resolving.

Figure 5.1 Vertiv™ Liebert® APM2 Lithium Battery Module Touchscreen

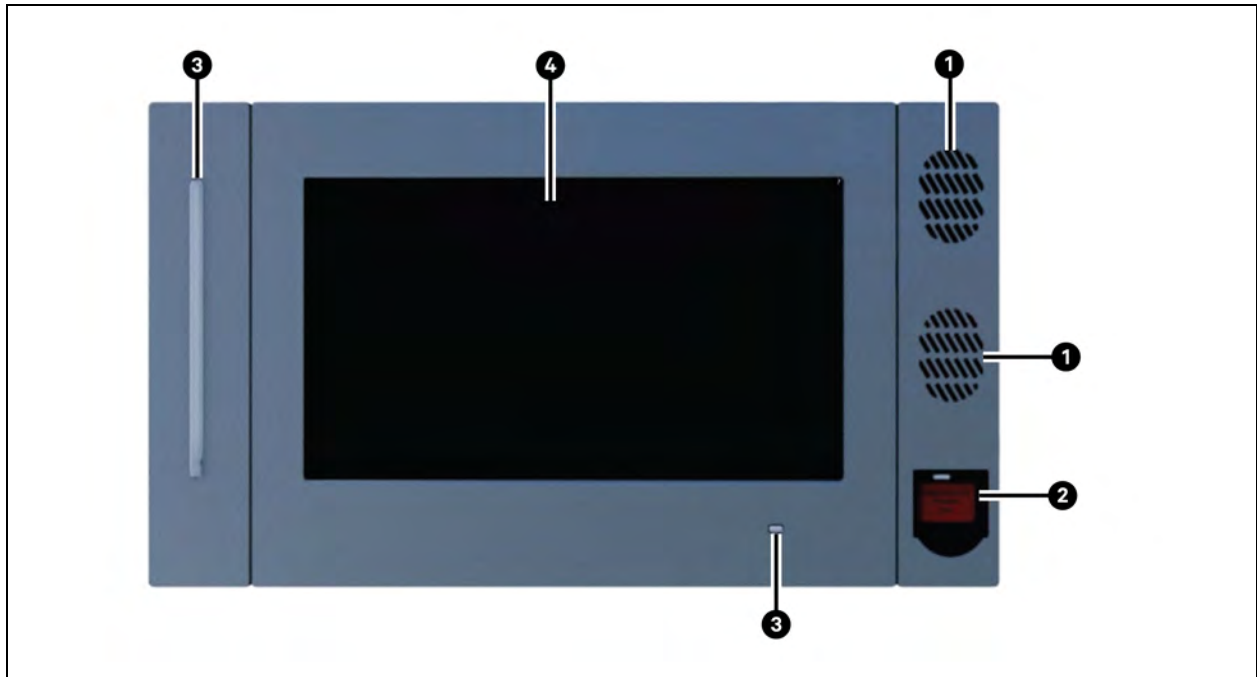

Item	Description
1	Speakers
2	EPO switch
3	UPS status LED
4	Touchscreen LCD

The main interface of the system after startup is shown below. See **Figure 5.2** below.

Figure 5.2 Home Page

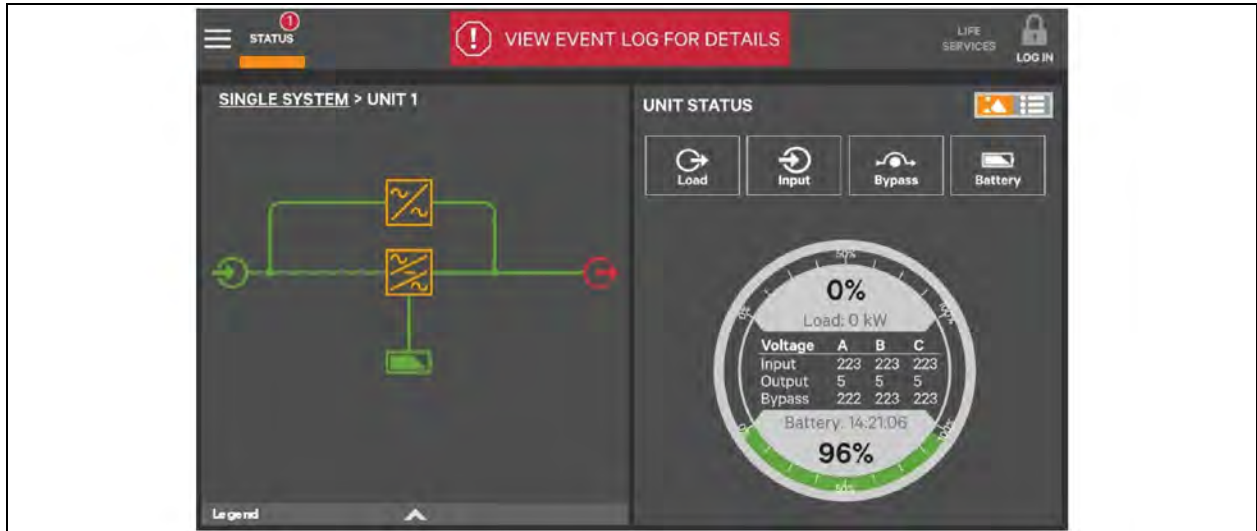

Figure 5.3 below shows the main screen of the HMI display about the lithium battery module information, click battery icon on the main screen. The specific lithium battery module information is displayed on the right side.

Figure 5.3 Main Screen Lithium Battery Module

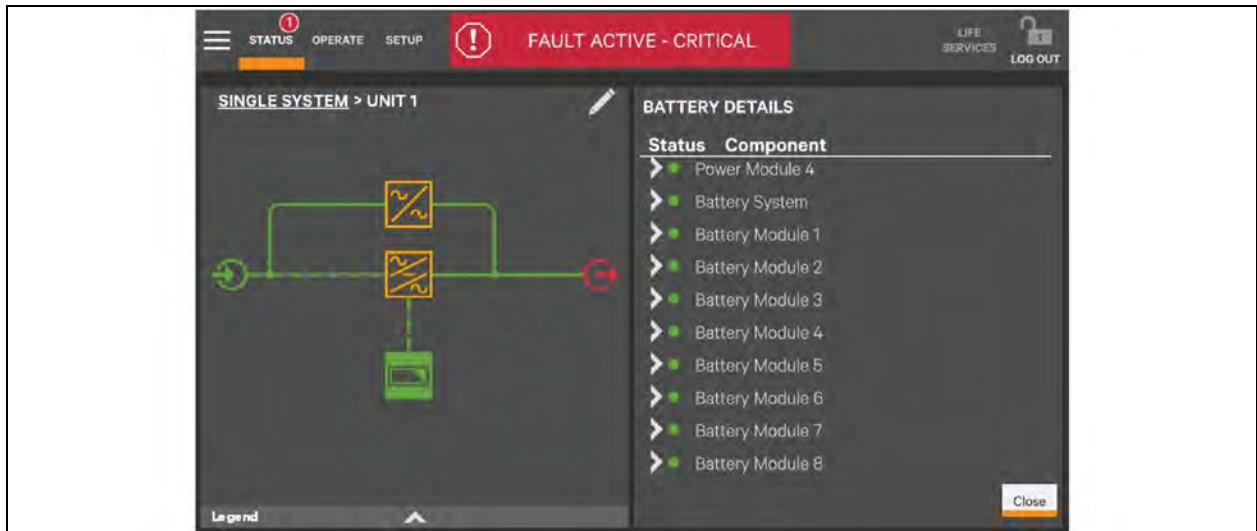

Figure 5.4 Lithium Battery Status

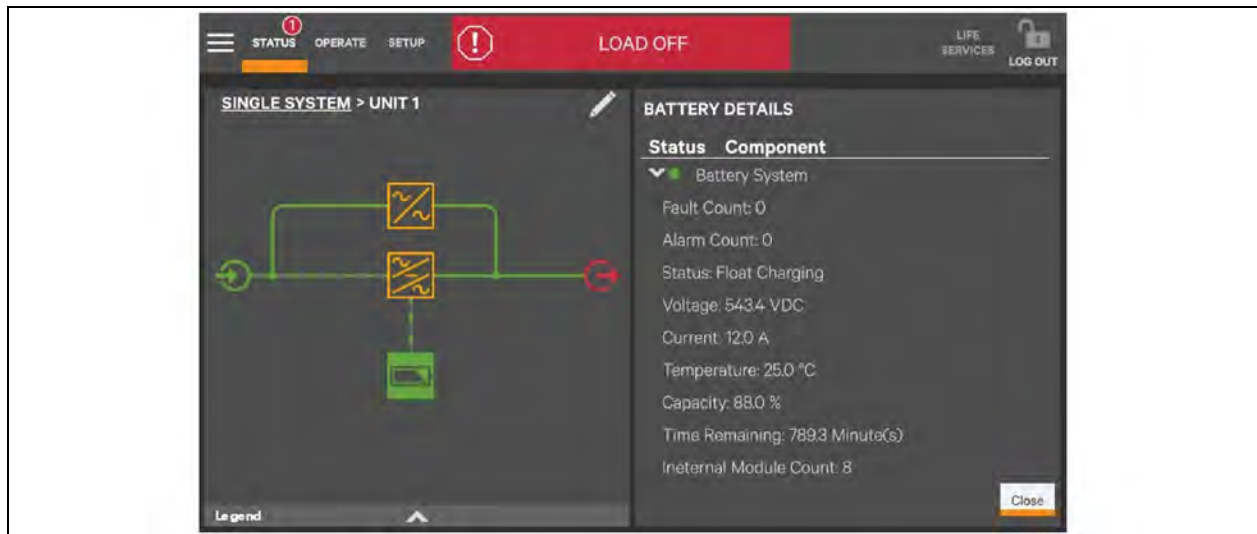

Figure 5.5 below shows the main screen of the HMI display about the lithium module information, click battery icon on the main screen. The specific lithium battery module information will be displayed on the left side.

Figure 5.5 Battery Report—Unit Status

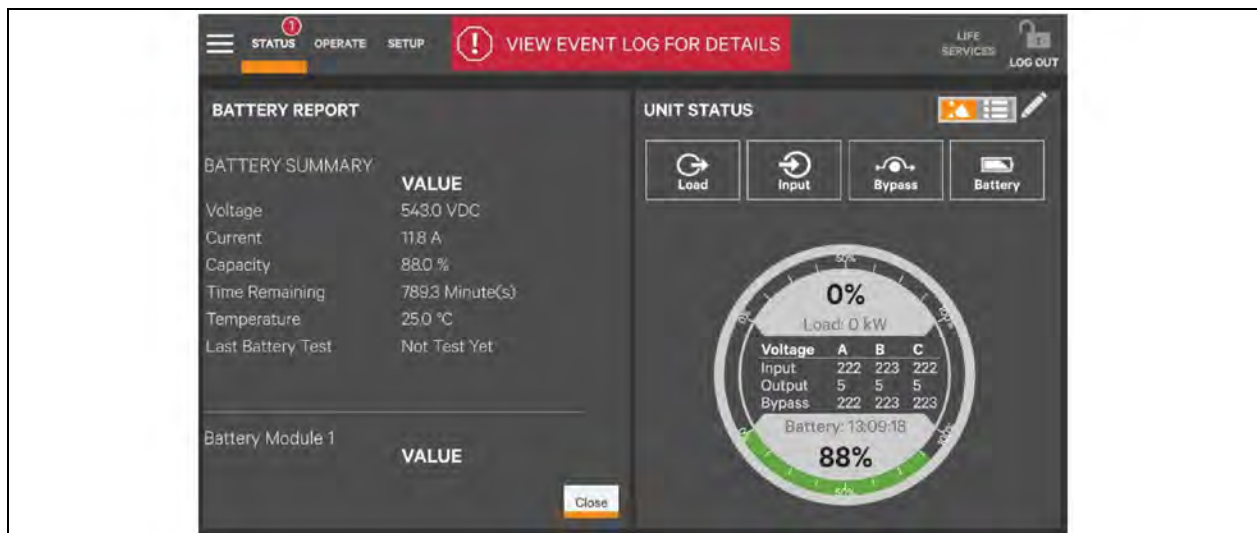

Figure 5.6 Event Log Details



Figure 5.7 below shows the HMI display of the lithium module specific information, click on the *STATUS* in the upper left corner of the main screen then click on the horizontal ellipses and then click on *BATTERY MONITOR*.

Specific battery discharge statistics are listed below:

Figure 5.7 Battery Discharge Statistics

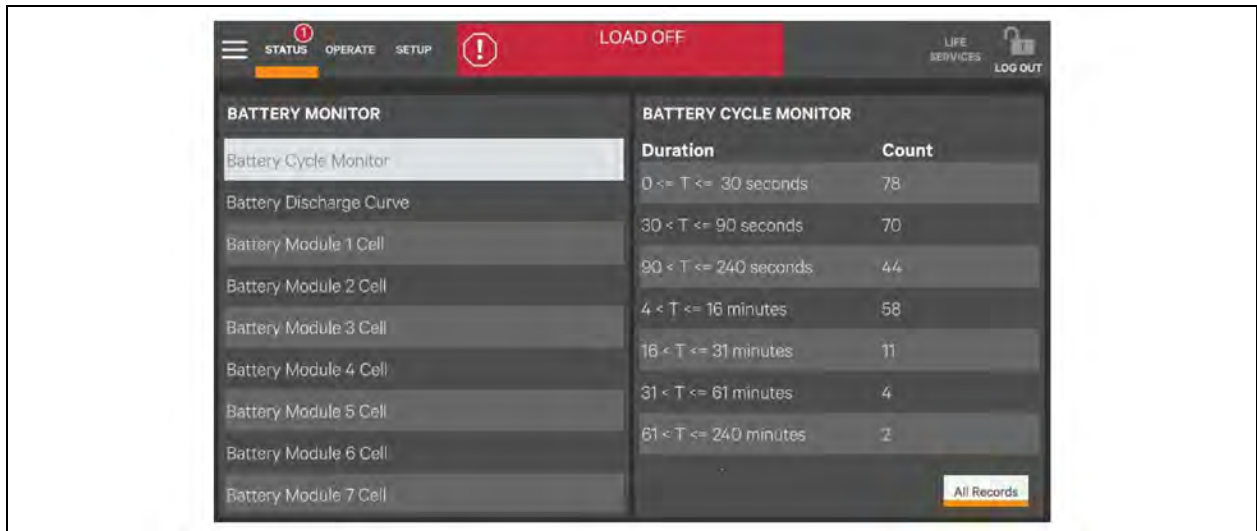

Figure 5.8 below shows the battery discharge curve displayed by the HMI as below:

Figure 5.8 Battery Discharge Curve

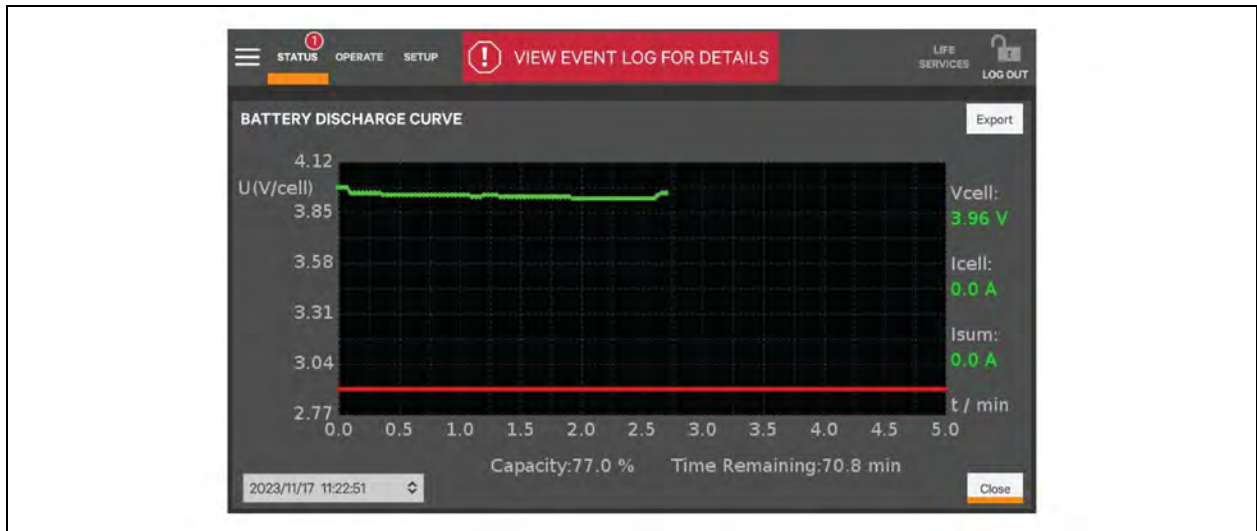

Figure 5.9 below shows the battery voltage and temperature data displayed by the HMI as below:

Figure 5.9 Battery Specific Voltage and Temperature Data

The screenshot displays the 'BATTERY MONITOR' interface. The table shows the following data:

Cell	Volt.(V)	Temp.(°C)
1	4.117	23.0
2	4.117	23.0
3	4.117	23.0
4	4.117	23.0
5	4.117	23.0
6	4.117	23.0
7	4.117	22.0
8	4.117	22.0

The screen also shows a 'FAULT ACTIVE - CRITICAL' warning.

Figure 5.10 Battery Specific Voltage and Temperature Data

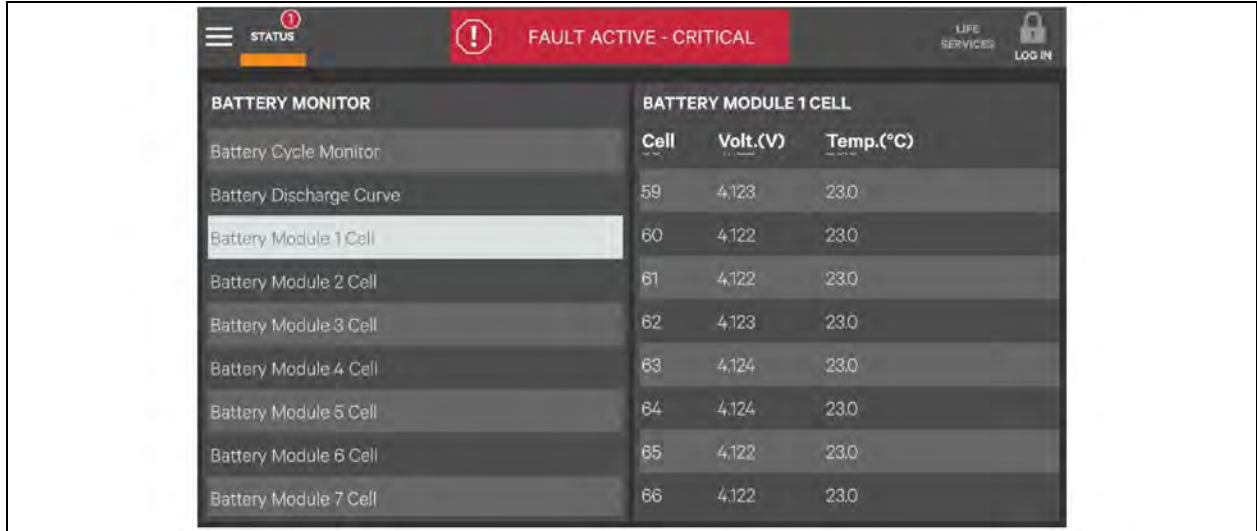

Figure 5.11 below shows the specific information of the lithium battery module of the HMI display, click on the *STATUS* in the upper left corner of the main screen then click on horizontal ellipses. Then click on *ABOUT*, to view the specific version of the battery information and the program version of module 1 to module 8.

Figure 5.11 Software Program Version

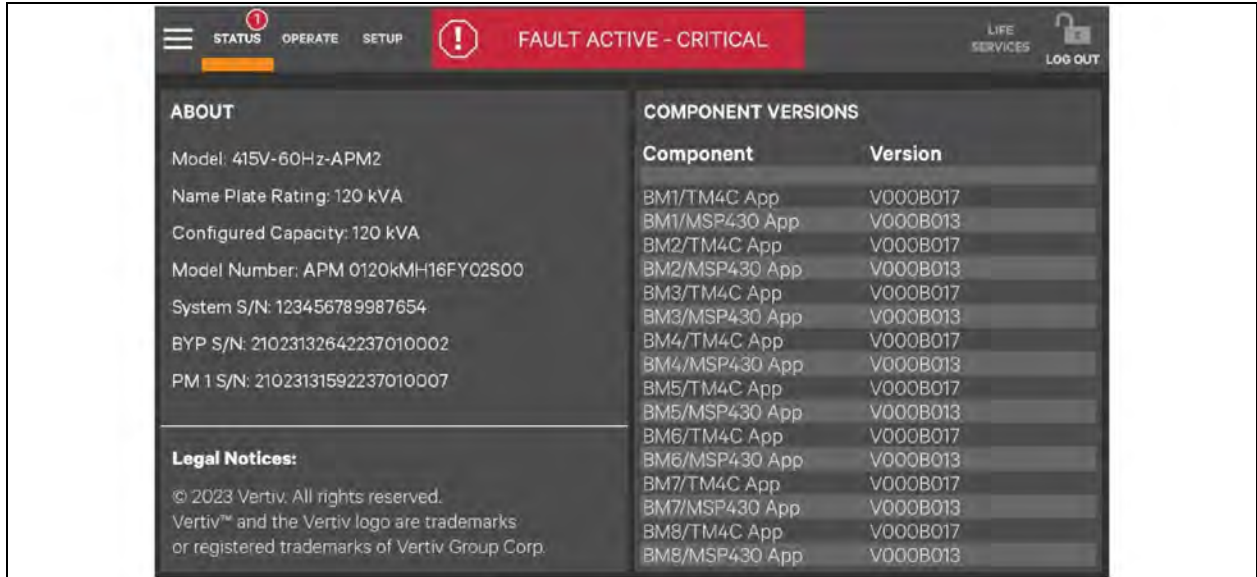

Figure 5.12 below shows the specific information of the lithium battery module of the HMI display, click on the *STATUS* in the upper left corner of the main screen then click on horizontal ellipses and then click on *EVENT LOG*, to view the specific log information of the battery.

Figure 5.12 Event Log Messages

Date/Time	Type	ID	Status	Com.	Description
2023-11-28 16:13:04.536	Warning	21F1	Clr	BM7	Batt. Module Disconnected
2023-11-28 16:13:02.492	Warning	21F1	Clr	BM6	Batt. Module Disconnected
2023-11-28 16:13:00.452	Warning	21F1	Clr	BM5	Batt. Module Disconnected
2023-11-28 16:12:58.309	Warning	21F1	Clr	BM4	Batt. Module Disconnected
2023-11-28 16:12:56.267	Warning	21F1	Clr	BM3	Batt. Module Disconnected
2023-11-28 16:12:54.125	Warning	21F1	Clr	BM2	Batt. Module Disconnected
2023-11-28 16:12:53.244	Warning	2021	Clr	PM4	No Battery

Figure 5.13 below shows the specific information of the lithium battery module on the HMI display, click on the *STATUS* in the upper left corner of the main screen, and then click on horizontal ellipses. Then click on *COMPONENT STATUS*, to view the lithium module component status.

Figure 5.13 Component Status

Status	Name
●	Battery System
●	Battery Module 1
●	Battery Module 2
●	Battery Module 3
●	Battery Module 4
●	Battery Module 5
●	Battery Module 6
●	Battery Module 7

Property	Value
Fault Count	0
Alarm Count	0
Status	Float Charging
Voltage	541.6 VDC
Current	12.1 A
Temperature	24.0 °C
Capacity	84.0 %
Time Remaining	7534 Minute(s)
Internal Module Count	8
External Cabinet Count	0

5.2 LED Display

Figure 5.14 LED Indicators

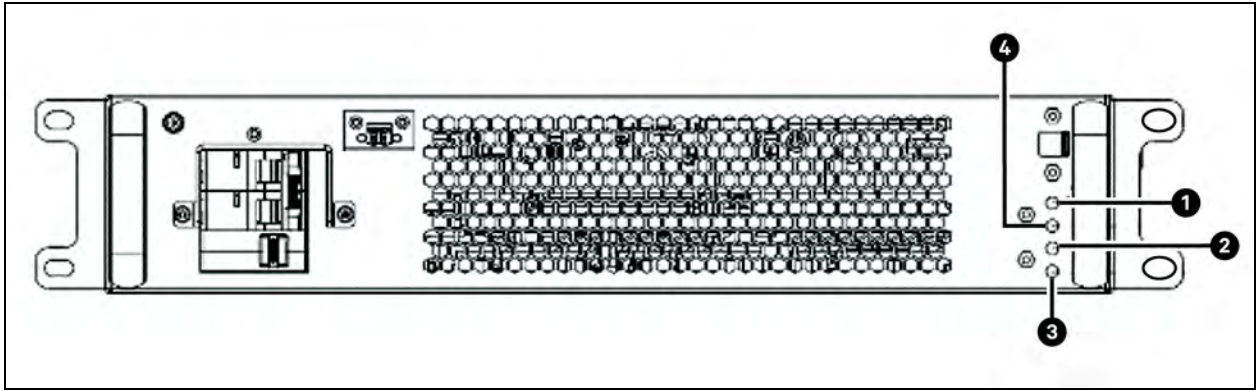

Item	Name	Descriptive	Operational State
1	HV status	High voltage indicator, green	Always On: High voltage power ON Normally extinguished: High voltage under power
2	PRECHG/CHG/DISCHG	Charge, discharge, stand indicator, green	Always On: Charging Flashing: Discharge Normally extinguished: Standing
3	BMS status	Low voltage indicator, green	Always On: BMS low voltage power ON Normally extinguished: BMS low voltage down
4	FAULT status	Fault indicator, red	Always On: Module fault Normally Off: Module is normal

5.3 Operation of Touchscreen

5.3.1 Access level login

The touchscreen has three access levels: observer, operator, and administrator, and provides different permissions and functions respectively.

Table 5.1 Access Level Login

Access Level		Observer	Operator	Administrator	Functional Description
Initial login password		No password required	1234	2345	LED Display on the previous page
UPS status		√	√	√	Operation of Touchscreen above
Operation	Alarm mute		√	√	LED Display on the previous page
	inverter operated switch on		√	√	
	Inverter shutdown		√	√	
	fault clearance		√	√	
	Energy saving mode switch		√	√	
	Forced equalization of batteries		√	√	
Set-up	Network interface settings			√	
	Dial display settings			√	
	Sound alarm or not			√	
	Energy saving mode setting			√	
	Automatic equalization setting			√	

NOTE: The initial password is the factory default, only administrator can change the password.

NOTE: Unauthorized changes in settings and operations can cause damage to the equipment. Change the default password as soon as possible to prevent unauthorized persons from changing the UPS operation or even shutting down the UPS. Operator and administrator passwords can be changed at the administrator level.

5.3.2 Touchscreens

The main screen after power ON is shown in **Figure 5.15** below. The information on the main screen is visible to all access level users.

Figure 5.15 Components Display at Main Page

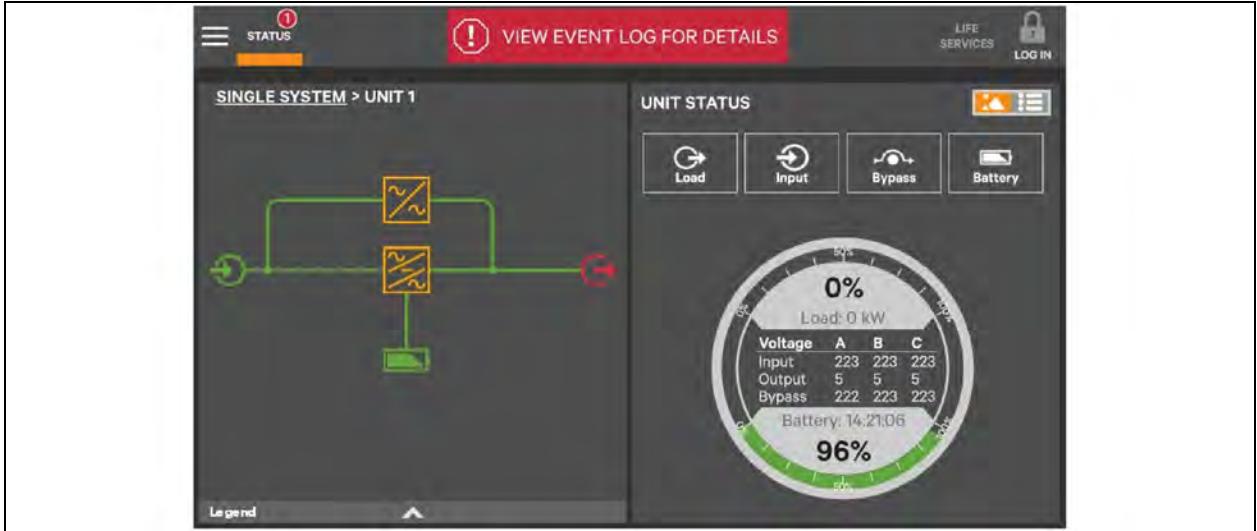

On the main page, the right side displays the current battery system's available power status SOC.

Figure 5.16 Components Display at Main Page

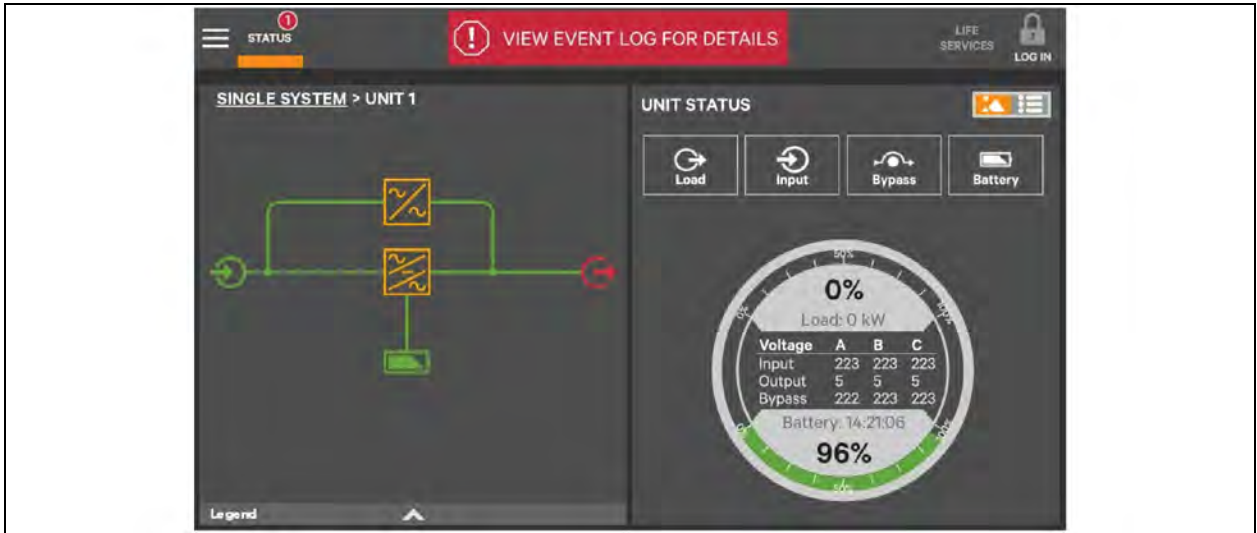

5.4 Alarm List

The **Table 5.2** on the next page provides a complete list of all Vertiv™ Liebert® APM2 lithium battery module alarm messages that are displayed in the real time alarms and history menus.

Table 5.2 Alarm List

Serial Number	Alarm	Meanings
1	Voltage sensor failure	Single unit voltage sampling fault, stop output.
2	Temperature sensor failure	Battery module internal temperature sensor malfunctioned, stopping output.
3	internal communications failure	Battery inter-module communication failure, stop output.
4	Input overvoltage fault	Liebert® APM2 lithium battery module terminal voltage too high, stop output.
5	input reversal fault	Liebert® APM2 lithium battery module terminals reverse positive and negative polarity, stop output.
6	Contacting sticking failure	Contacting sticks and stops output.
7	Battery cell low voltage alarm	Battery unit voltage is too low warning, warning does not operate.
8	Battery single high voltage alarm	Battery single high voltage warning, warning inactive.
9	Battery discharge low voltage alarm	Battery module voltage is too low warning, the warning does not action.
10	Battery pack charging high voltage alarm	Battery module voltage overvoltage warning, warning inactivity.
11	Battery pack charging low temperature alarm	Low battery module temperature warning when charging, warning does not work.
12	Battery pack charging high temperature alarm	Battery module temperature overheat warning when charging, warning does not work.
13	Battery discharge low temperature alarm	Low battery cell temperature warning when discharging, warning does not operate.
14	Battery discharge high temperature alarm	Warning of high battery cell temperature when discharging, warning does not operate.
15	Battery pack charging overcurrent alarm	Battery clusters in the charging time charging current is greater than the allowable safe charging current warning, warning does not operate.
16	Battery pack discharge overcurrent alarm	Battery cluster in the discharge of the discharge current is greater than the permissible safety discharge current warning, warning does not operate.
17	Single board low voltage alarm	Battery module low voltage warning, warning inactivity.
18	Single board high voltage alarm	Battery module voltage high warning, warning inactive.
19	Battery undervoltage protection	Battery cell voltage under low secondary, protection cut off output.
20	Battery overvoltage protection	Battery cell voltage overvoltage secondary, protection cut off output.
21	Battery pack discharge undervoltage protection	Undervoltage secondary protection when the battery module is discharged, protection cuts off the output.
22	Battery pack charging overvoltage protection	Overvoltage secondary protection during battery module charging, protection cuts off outputs.

Table 5.2 Alarm List (continued)

Serial Number	Alarm	Meanings
23	Charging low temperature protection	Low temperature secondary protection when charging, protection cuts off the output.
24	Charging high temperature protection	High temperature secondary protection when charging, protection cut off output.
25	Discharge cryoprotection	Low temperature secondary protection when discharging, protection cuts off the output.
26	Discharge heat protection	High temperature secondary protection when discharging, protection cuts off the output.
27	Battery pack charging overcurrent protection	Battery module in the charging current is greater than the allowable charging current secondary protection, protection cut off the output.
28	Battery pack discharge overcurrent protection	Battery module in the discharge of current greater than the allowable charging current secondary protection, protection cut off the output.
29	PCB undervoltage protection	Battery module voltage is too low secondary protection, protection cut off the output.
30	PCB overvoltage protection	Battery module overvoltage secondary protection, protection cut off the output.
31	BCMS communication failure	Failure of CAN communication between EMS and BCMS, protection cut off outputs.

6 Product Specification

This chapter provides product specifications for the Vertiv™ Liebert® APM2 lithium battery module.

6.1 Applicable Standards

The Liebert® APM2 lithium battery module is designed to meet European and international standards as shown in **Table 6.1** below.

Table 6.1 European and International Standards

Item	Standard
General safety requirements	EN62040-1/IEC62040-1
EMC requirements	EN62040-2/IEC62040-2 (CATEGORY C3)
Cell performance determination methodology and function, safety requirements	IEC62619, UL1642
Road transport safety standards	UN38.3

NOTE: The product standards listed in **Table 6.1** above, refer to the relevant provisions of the IEC and EN general standards for safety, electromagnetic radiation and immunity, and construction.

6.2 Environmental Characteristics

Table 6.2 Environmental Characteristics

Item	Unit	Characteristics
Altitude	m	≤3000
Relative humidity	%RH	0 to 95, no condensation
Operating temperature	°C	Allowable charging temperature range: 0 to 55, optimal charging temperature range: 15 to 30. Allowable discharge temperature range: -35 to 78, optimal discharge temperature range: 15 to 30.
Storage temperature	°C	0 to +40
Transportation temperature	°C	-10 to 45
Recommended battery storage temperature	°C	15 to 35 (20 to 25 is the optimum battery storage temperature).
Low temperature discharge capacity/energy retention	/	≥70% (0°C, 1C) ≥60% (-10°C, 1C) ≥50% (-20°C, 1C)

6.3 Mechanical Characteristics

Table 6.3 Mechanical Characteristics

Item	Unit	Physical Parameter
Mechanical dimensions (W×D×H)	mm	796 x 440 x 87 (without package)
		1000 x 800 x 400 (with package)
Weight (maximum)	kg	36
Color	N/A	Panel EG7021
Protection class, IEC (60529)	N/A	IP20

6.4 Electrical Characteristics

Table 6.4 Electrical characteristics

Item	Specification
Single module charge limit voltage	277.86V
Series system limit voltage	555.72V
Single module rated voltage	237.6V (3.6V)
Series system rated voltage	475.2V (3.6V)
Single module discharge cutoff voltage	191.4V
Series system discharge cutoff voltage	382.8V
Typical capacity	14Ah
Maximum discharge current	168A (single string system)
Maximum charging current	10A (single string system)
Initial internal resistance value	≤200mΩ (measure its AC impedance at ac 1kHz under half-charged condition.)
Factory open circuit voltage	256V-264V (3.9V-4.0V/cell)
Charge and discharge energy efficiency	≥95% (25 °C, 1C)
Room temperature charge retention/capacity recovery rate	≥95% (25 °C, 100% SOC, 28 d)
Protection class	I
Overvoltage class	II
External short-circuit parameters	Current 1412A, time 11ms

7 Maintenance and Service

Vertiv™ Liebert® Lithium-ion UPS systems (including lithium-ion modules) require regular maintenance and maintenance during long term operation. Effective maintenance and maintenance of lithium battery modules can reduce the risk of lithium battery module failure and provide a longer service life. This chapter mainly describes the preventive maintenance, replacement, and quick diagnosis of common abnormal problems of the lithium battery module.

7.1 Maintenance Precautions

The routine inspection and maintenance of the lithium battery module can be carried out by personnel who have received relevant training, and the inspection and replacement of its components should be carried out by Vertiv authorized professionals. The parts behind the protective cover that can be opened only by tools are not operable by users. Only qualified maintenance personnel are allowed to open the protective cover. When maintaining the lithium battery module, use the insulated tools to ensure the safe electrical operation.

When using lithium battery modules, pay attention to the below points:

- Even if the lithium battery module is not running, there is still a deadly dangerous voltage inside it. Before maintenance of the module, to ensure safety, it is necessary to measure the voltage between the site to be operated and the ground to ensure that it is lower than the dangerous voltage value, that is the DC is lower than 60 VDC.
- When using lithium battery modules, do not wear watches, bracelets, rings, and other conductive items on your hands.
- When in doubt about the use of the equipment, ask the personnel familiar with the equipment.

7.2 Preventive Maintenance

To improve the reliability and stability of the lithium battery module operation, it is necessary to complete the preventive maintenance work during the use of regular inspections:

- Regularly inspect the operating environment, check the temperature and humidity of the working environment of the lithium module, and keep record of the data to ensure that the lithium module operates in the best environmental conditions.
- Regularly check the operation of the fan of the supporting UPS, if the fan operation fails, immediately replace the corresponding power module.
- If the operation site is dusty, clean or replace the dust net of the cabinet every half a year to avoid the temperature inside the cabinet rising due to poor air ducts, which affects the operation life of lithium battery modules.
- Regularly check the SOC and SOH of all lithium modules to ensure that the lithium modules are in good operating condition.
- Use the upper computer or use the network background at any time to monitor the operating status of the entire machine, alarms or failures in time to troubleshooting.

7.3 Module Replacement

IMPORTANT! Module replacement operations must be performed by Vertiv service personnel.

Before module replacement you, it is necessary to confirm the operating status of the supporting UPS and the load situation, to avoid the operation affecting the UPS power supply for the load.

Before and after the module replacement, confirm that the module is not mixed with other types of battery modules such as lead-acid modules.

If a malfunction occurs that requires lithium module replacement, refer to the below procedure:

1. Disconnect the lithium battery module circuit breaker, fully power OFF the lithium battery module, turn the lock switch to the unlocked state, and wait for all the lithium battery module indicator lights to be OFF.
2. Remove the fixing screws on both sides of the front panel of the lithium battery module and pull out the module.
3. Insert the prepared new lithium battery module or the maintained module back into its original position and tighten the fixing screws with a tool.
4. Toggle the module's lock switch to a locked state, close the module's blanking switch, and wait for the module to join the power reserve.

NOTE: During operation, use insulated tools, insulated safety shoes and a safety officer should be available onsite to ensure safe operation.

NOTE: When the battery module is pulled out halfway, care needs to be taken to protect the safety of the battery module from slipping off.

IMPORTANT! The voltage of the lithium battery module and SOC consistency is very important for the normal operation of the system, in the process of replacing the lithium battery module, it is recommended that the total voltage difference between the newly replaced lithium module and the lithium battery module in the same cluster of batteries is less than 10 V, to avoid affecting the ability to prepare for the power.

IMPORTANT! When replacing a module in a battery cluster, it is recommended that the air switch of the other lithium battery module in the cluster be synchronized OFF.



WARNING! It is prohibited to open or disassemble the lithium battery module on site.



WARNING! Recycling of lithium battery modules should comply with local regulations.



WARNING! Make sure that the circuit breaker is disconnected, and the lock switch is toggled to the unlocked state when replacing the lithium battery module. If transportation is required, it is recommended to use the original package of Vertiv.

7.4 Routine Maintenance

7.4.1 General

The factory SOC of the Vertiv™ Liebert® APM2 lithium battery module is 70% to 80%. When using the APM2 for the first time, start the UPS to charge the lithium battery module. During this process, the lithium battery module has the power backup capability, but the backup time is shorter than the standard value.

Lithium battery modules need to be regularly replenished during long term storage, supplementing the SOC to more than 40%.

When cleaning the lithium battery module shell, only use a wet rag to wipe, do not use alcohol, gasoline, diluent, and other organic solvents.

Periodically check the ambient temperature of the lithium battery module. The most suitable temperature for the battery is 20°C to 25°C.

Regularly check the MCB and lock of the Liebert® APM2 lithium battery module for anomalies to ensure that the input or output can be cut off when the current is too large.

Maintenance personnel should be familiar with the typical operating conditions of the Liebert® APM2 lithium battery module so that they can quickly locate the abnormal environmental conditions should also be familiar with the Liebert® APM2 lithium battery module display light display state.

7.4.2 Diagnosis of common problems

Table 7.1 Diagnosis of Common Problems

Serial Number	Abnormal Phenomenon	Possible Causes
1	The touchscreen reports a battery communication failure.	Poor connection of battery cell module, loose can communication cable.
2	System overload reported after utility battery cut.	Mismatch between the number of battery modules and load power.
3	Utility power is normal, but the lithium module is not charging.	The total voltage of battery module is abnormal or normal communication is not established.
4	High voltage indicator does not light up after the battery air switch is closed.	Faulty high voltage indicator or abnormal power supply to the main channel or faulty high voltage abnormality.
5	Battery module red light on.	Battery module failure.

7.4.3 Emergency management

When the system reports a malfunction and the touchscreen lights up yellow or red, first check the type of malfunction through the touchscreen to determine the cause of the malfunction. If it is caused by a battery malfunction, confirm the type of malfunction, open the door of the cabinet, and observe the front panel of the lithium-ion module to see if it is lit up with a red light, turn off the malfunctioning battery if necessary, to avoid the malfunction from expanding, and notify the Vertiv technical service personnel in time.

Disassembly of faulty modules is prohibited and must be handled by Vertiv authorized personnel.

7.5 Maintenance Record of Lithium Battery Module

Table 7.2 Vertiv™ Liebert® APM2 Lithium Battery Module Maintenance Record Sheet

Form	Test Items	Record	Test Items	Record
Environmental indicators	Temp		Humidity level	
	Dust mesh status		Power module fans	
Lithium module basic information	Lithium module equipment code		Device status	
	Service life		Total battery pack voltage	
	Current SOC		Current SOH	

Table 7.2 Vertiv™ Liebert® APM2 Lithium Battery Module Maintenance Record Sheet (continued)

Form	Test Items	Record	Test Items	Record
Battery parameter logging	Maximum cell voltage		Minimum cell voltage	
	Maximum cell temperature		Minimum cell temperature	
Warning	Current alarms		Historical alarm messages	
	Historic preservation information		Historical fault information	

8 Packaging, Transportation, Storage

8.1 Package

The packaging of lithium battery modules meets the requirements of ISTA 3B for package transportation, with labels printed on the boxes for fear of moisture, careful and light handling, upward, and number of stacked layers, to prevent dropping, squeezing, and tipping. Contact the carrier and Vertiv local service personnel in a timely manner in case of any damage to the packaging caused by dropping, tipping, and squeezing. If the lithium module needs to be repacked, the original Vertiv packaging needs to be used.

8.2 Transport

When transporting or handling lithium battery modules, strictly follow the warning labels on the packing cases. Do not transport flammable, explosive, or corrosive materials together. Lithium battery module with UN38.3 and dangerous package certification can use land transport, air transport, sea transport. It is recommended to use lithium battery transport qualifications of the car transport, and choose a better road condition, to avoid too much turbulence.

8.3 Storage

If the lithium battery module does not need to be installed immediately, store the module indoors with the original package to avoid excessive humidity or high temperature. Lithium battery modules need to be stored in a dry, low temperature, well-ventilated place, the most suitable storage temperature is 20°C to 25°C, not with flammable, explosive, corrosive, and strong magnetic items common storage.

The lithium battery module is stored for more than three months without use and must be tested by the after sales engineer of Vertiv before use.

This page intentionally left blank

Appendices

Appendix A: Technical Support and Contacts

A.1 Technical Support/Service in the United States

Vertiv Group Corporation

24x7 dispatch of technicians for all products.

1-800-543-2378

Liebert® Thermal Management Products

1-800-543-2378

Liebert® Channel Products

1-800-222-5877

Liebert® AC and DC Power Products

1-800-543-2378

A.2 Locations

United States

Vertiv Headquarters

505 N Cleveland Ave

Westerville, OH 43082

Europe

Via Leonardo Da Vinci 8 Zona Industriale Tognana

35028 Piove Di Sacco (PD) Italy

Asia

7/F, Dah Sing Financial Centre

3108 Gloucester Road, Wanchai

Hong Kong

Appendix B: Battery Backup Timetable

Table 9.1 Battery Backup Timetable

Battery Data	Backup Time BOL-45 °C										
	Output Load Percentage	10%	20%	30%	40%	50%	60%	70%	80%	90%	100%
	Output Load Power (kW)	12	24	36	48	60	72	84	96	108	120
1	Battery power per string (kW)	12	24	30*	-	-	-	-	-	-	-
	Backup time BOL (min)	27	14	10	-	-	-	-	-	-	-
2	Battery power per string (kW)	6	12	18	24	30*	-	-	-	-	-
	Backup time BOL (min)	52	27	18	14	10	-	-	-	-	-
3	Battery power per string (kW)	4	8	12	16	20	24	28	32	30*	-
	Backup time BOL (min)	77	40	27	20	16	14	12	9	10	-
4	Battery power per string (kW)	3	6	9	12	15	18	21	24	27	30*
	Backup time BOL (min)	101	52	35	27	22	18	16	14	12	10

NOTE: This reserve schedule corresponds to the discharge time at 25 °C and full charge.

String Count	Backup Time BOL-45 °C										
	Output Load Percentage	10%	20%	30%	40%	50%	60%	70%	80%	90%	100%
	Output Load Power (kW)	12	24	36	48	60	72	84	96	108	120
1	Battery Power per String (kW)	12	24	30*	-	-	-	-	-	-	-
	Backup Time BOL (min)	24.3	12.6	9	-	-	-	-	-	-	-
2	Battery Power per String (kW)	6	12	18	24	30*	-	-	-	-	-
	Backup Time BOL (min)	46.8	24.3	16.2	12.6	9	-	-	-	-	-

String Count	Backup Time BOL-45 °C										
	Output Load Percentage	10%	20%	30%	40%	50%	60%	70%	80%	90%	100%
	Output Load Power (kW)	12	24	36	48	60	72	84	96	108	120
3	Battery Power per String (kW)	4	8	12	16	20	24	28	32	30*	-
	Backup Time BOL (min)	69.3	36	24.3	18	14.4	12.6	10.8	8.1	9	-
4	Battery Power per String (kW)	3	6	9	12	15	18	21	24	27	30*
	Backup Time BOL (min)	90.9	46.8	31.5	24.3	19.8	16.2	14.4	12.6	10.8	9

NOTE: This reserve schedule corresponds to the discharge time at 45 °C and full charge.

Appendix C: Hazardous Substances and Content

Table 9.2 Hazardous Substances and Content

Part Name	Hazardous Substances									
	Cadmium	Mercury (chemistry)	Chromium	Hexavalent chrome	Polybrominated biphenyl	Polybrominated diphenylether	Bis (2ethylhexyl) phthalate	Butylbenzyl phthalate	Dibutyl phthalate	Diisobutyl phthalate
	(Pb)	(Hg)	(Cd)	(Cr (VI))	(PBB)	(PBDE)	(DEHP- Di (2-ethylhexyl) Phthalate)	(BBP- Benzyl Butyl Phthalate)	(DBP- Di-n-butyl Phthalate)	(DIBP- Diisobutyl Phthalate)
Hexagonal copper studs	x	○	○	○	○	○	○	○	○	○
Finished plate	x	○	○	○	○	○	○	○	○	○
AC capacitor	x	○	○	○	○	○	○	○	○	○
DC capacitance	x	○	○	○	○	○	○	○	○	○
Fan	x	○	○	○	○	○	○	○	○	○
Cable	x	○	○	○	○	○	○	○	○	○
LCD	x	○	○	○	○	○	○	○	○	○
Detection element	x	○	○	○	○	○	○	○	○	○
Magnetic element	x	○	○	○	○	○	○	○	○	○
CB/rotary switch	x	○	○	○	○	○	○	○	○	○
Semiconductor device	x	x	○	○	○	○	○	○	○	○
Electric core	x	○	○	○	○	○	○	○	○	○

NOTE: This table is made according to the regulation of SJ/T 11364.

○ : Means the content of the hazardous substances in all the average quality materials of the parts is within the limits specified in GB/T 26572.

x: Means the content of the hazardous substances in at least one of the average quality materials of the parts is outside the limits specified in GB/T 26572.

Applicable scope: Lithium battery module

Connect with Vertiv on Social Media



<https://www.facebook.com/vertiv/>



<https://www.instagram.com/vertiv/>



<https://www.linkedin.com/company/vertiv/>



<https://www.twitter.com/Vertiv/>



Vertiv.com | Vertiv Headquarters, 505 N Cleveland Ave, Westerville, OH 43082 USA

©2024 Vertiv Group Corp. All rights reserved. Vertiv™ and the Vertiv logo are trademarks or registered trademarks of Vertiv Group Corp. All other names and logos referred to are trade names, trademarks or registered trademarks of their respective owners. While every precaution has been taken to ensure accuracy and completeness here, Vertiv Group Corp. assumes no responsibility, and disclaims all liability, for damages resulting from use of this information or for any errors or omissions.

SL-71173_REVB_03-24